

# CERA FAÇADE

## Builders Guide



# Contents

<b>HANDLING THE CERA FAÇADE PANELS</b> .....	<b>2</b>	<b>9. Fixing Panels horizontally</b> .....	<b>16</b>
1. Rain Screen System .....	3	with 15mm Clips .....	16
2. Panel Set-out .....	4	Sill .....	16
3. Wind Load and R-Value tables .....	4	Clips for Panels .....	17
<b>INSTALLATION ORDER</b> .....	<b>5</b>	Vertical Joints .....	17
1. Check the Frame .....	5	Inside Corner .....	18
Timber Frame .....	5	Outside Corner .....	18
Steel Frame .....	5	Metal Corner .....	18
2. Sill Flashing .....	6	Opening .....	19
3. Sarking .....	6	Sides .....	19
Adhesive Tape & Overlap of Sarking .....	6	Upper Part .....	19
4. Marking .....	7	Lower Part .....	19
For Starter Bar (15mm) .....	7	Eave .....	19
5. Accessories .....	7	Roof [Sloped] .....	20
Hidden Flashing .....	7	Roof [Horizontal] .....	20
Inside Corner .....	7	<b>10. Fixing Panels vertically</b> .....	<b>21</b>
Starter Bar .....	8	with 15mm Clips .....	21
Eave Flashing (ventilation type) .....	8	Sill .....	22
Hat-shaped Joiner (double-sided type) .....	8	Clips for Panels .....	22
Hat-shaped Joiner (one-sided type) .....	9	Vertical Joints .....	22
6. Measurement .....	9	Inside Corner .....	23
7. Cutting Panels .....	10	Outside Corner .....	23
Cutting Equipment .....	10	Metal Corner .....	23
Blade .....	10	Opening .....	24
How to Cut .....	10	Sides .....	24
Spacer .....	10	Upper Part .....	24
Protective Equipment .....	10	Lower Part .....	24
Treatment of Panel Cut Surfaces .....	11	Eave .....	24
8. Opening details .....	12	Roof [Sloped] .....	25
Window head horizontal .....	12	Roof [Horizontal] .....	25
Window head vertical .....	12	<b>11. Flashings</b> .....	<b>25</b>
Window sill .....	12	<b>12. Touch Up Paint</b> .....	<b>26</b>
Window jamb horizontal .....	13	<b>13. Sealant</b> .....	<b>27</b>
Window jamb vertical .....	13	Application Order .....	27
Door jamb vertical .....	14	<b>14. Replacing a Panel</b> .....	<b>29</b>
Level transition detail .....	15	<b>15. Health Precautions</b> .....	<b>30</b>
Wall expansion detail .....	15		

## Handling the CERA FAÇADE panels



- Carry the panels by holding their lengthwise edges under your arm.
- Take extra care to avoid hitting anything with the panels. Dropping the panels may damage the edges.
- Don't touch the panels with dirty hands.  
**CERA FAÇADE Panels are PRE-COATED!**

### HOW TO CARRY THE PANELS



### VERY IMPORTANT!



Avoid breathing silica dust. Viroc panels contained silica. Inhalation of respirable silica dust can cause Silicosis, a potentially disabling lung disease. When drilling, cutting or abrading cladding panels during installation or handling:

**1. Work outdoors where feasible or use mechanical ventilation.**

**2. Wear an approved respirator.**

**3. Warn others in the area.**

For further information refer to the material safety datasheet.

### Transporting Cera Façade panels

- When transporting the panels by vehicle, stack them flat.
- Tie the panels down and cover with plates to avoid damage or shifting when braking.
- Take extra care to avoid damaging panels when loading/unloading.
- When hoisting panels, always put spacers between the panels and ropes or straps to avoid damaging them.
- Do not stack pallets with more panels on the top of the pallet than underneath, as this could cause panels to collapse.



### Storage of Cera Façade panels

- Store panels flat and under cover. Keep the panels dry and off the ground prior to installation to avoid moisture conditions that could effect the quality of the work.
- Panels should not be stacked more than two pallets high and should be loaded with a fork-lift or sling, taking care not to drop the pallet.
- Keep panels clean when handling on site and take care not to damage the edges.
- If necessary to stand panels on edge prior to installation, take care to avoid rough or abrasive surfaces that could damage the factory-applied coating or sealer.
- Panels should be carried mid-span and on edge for ease of handling and to avoid breakage.

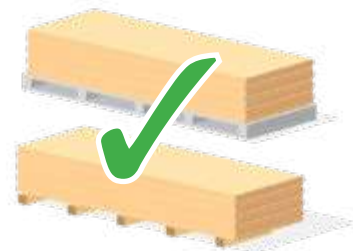

## 1. Rain Screen System

The Cera Façade system is a cavity-based extruded fibre-reinforced cement panel wall cladding. Cera Façade panels are available in a range of surface profile patterns and pre-finished colours and are rebated to form hidden laps. Panels are fixed with clips to form a drained and ventilated cavity.

The system incorporates a primary and secondary means of weather resistance (first and second line of defence) against water penetration by separating the cladding from the external wall framing with a nominal 15 mm drained and ventilated cavity.

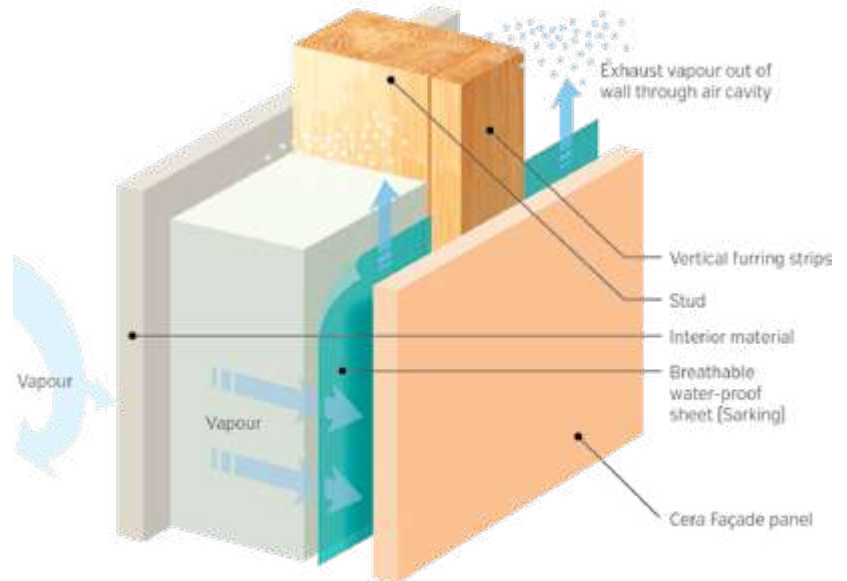

### Key points of the rain screen system

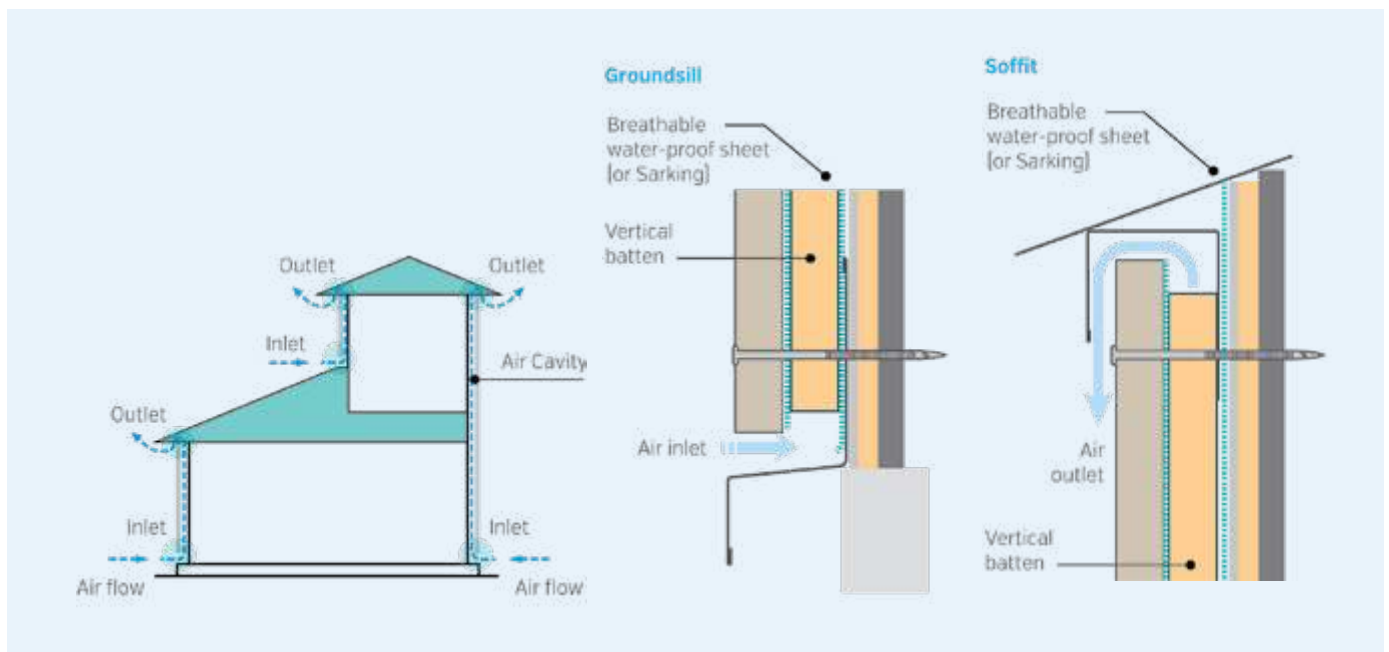

## 2. Panel set-out

- When laying out the panels, take into consideration the appearance of the building, the length of provided accessories and how to minimize material waste.
- Layout sealant joints in advance to create an aesthetically pleasing finish.
- Include the inside dimension of the pre-formed outside corners in consideration of panel arrangement.
- Vertical joints should be aligned with studs.
- Include the sealant joint width (10mm) for each vertical joint.
- Pay attention to window locations and eave soffit height to provide more than 150mm for the panels above and below window frames [B, C, figure below right] and panels below the soffit. [A].
- Avoid installing less wide panels in these locations.

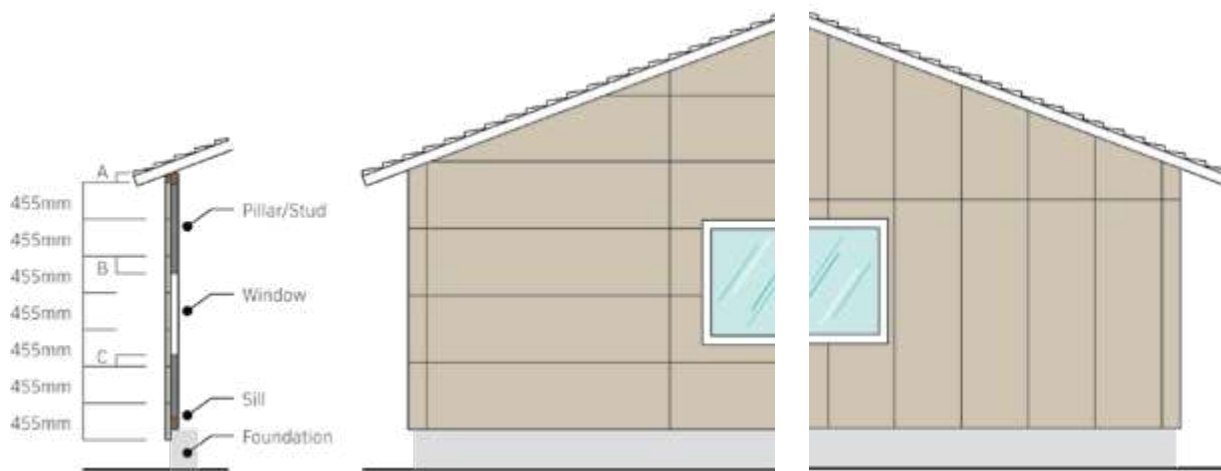

## 3. Wind load table and R values

Table 1: Cera Façade Panel Fixing Requirement

Wind Class to AS4055	Minimum Cera Façade Panel Fixing Requirement	
	General Areas	Corner Zones
N1	Panel clip at 600 mm ctrs.	Panel clip at 600 mm ctrs.
N2	Panel clip at 600 mm ctrs.	Panel clip at 600 mm ctrs.
N3	Panel clip at 600 mm ctrs.	Panel clip+ face fix at 600 mm ctrs.

Notes to Table 1:

1. Corner zone is within 1,200 mm of an external corner of a building.
2. Face fix is an additional mid width panel fixing to each stud with the following fasteners:
  - a. Timber frame - dia. 3 mm x 65 mm nail
  - b. Cold-formed steel frame - 50 mm countersunk head screw.

Table 2: Wall System R-Value - 16 mm Cera Façade Panel

Stud Cavity Width	Stud Cavity Added Insulation R-Value [m <sup>2</sup> K/W]	Wall System R-Value [m <sup>2</sup> K/W]	
		Winter	Summer
70	None	1.6	1.3
70	1.4	2.3	2.0
75	1.5	2.4	2.1
90	2.0	2.9	2.6

Notes to Table 2:

1. System R-Value includes air films and non-ventilated cavity air space in accordance with AS/NZS 4859.1:2002 [incorporating Amendment No.1].
2. Minimum 9 mm thick plasterboard lining internal.
3. 15 mm cavity between Cera Façade Panel and the stud frame.
4. R 0.2 m<sup>2</sup>K/W may be added to the system R-Value when the vapour barrier is reflective.

## Installation order

Timber frame/steel frame with clips (15mm)

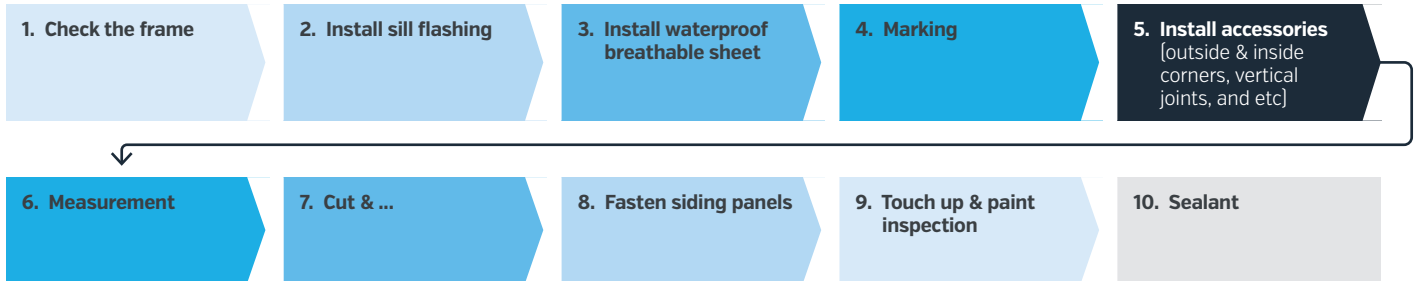

### 1. Check the frame

#### Timber frame

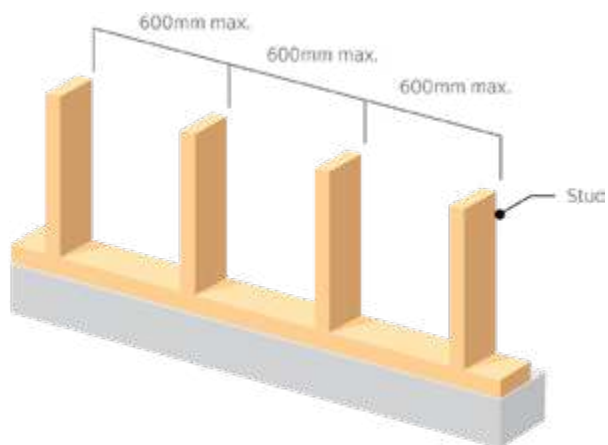
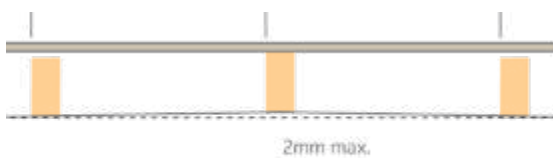

#### Steel frame

##### A. Frame vertical unevenness

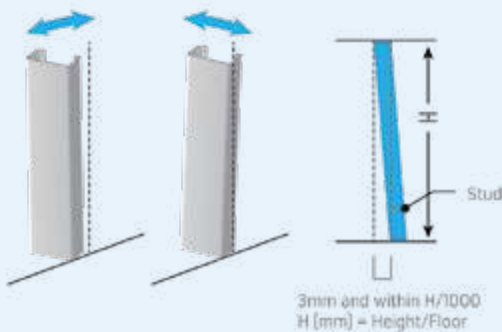

##### B. Eye of height unevenness



##### C. Stud evenness

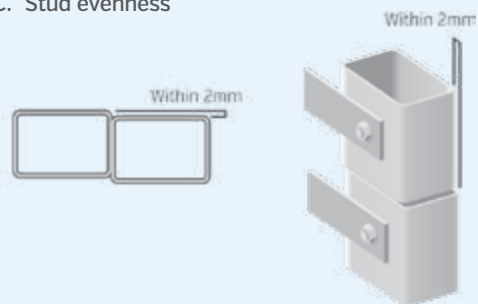

##### D. Screw heads & sash frame fringe

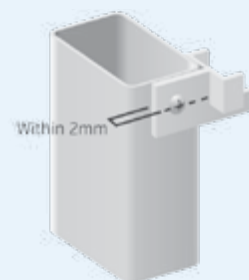

## 2. Sill flashing

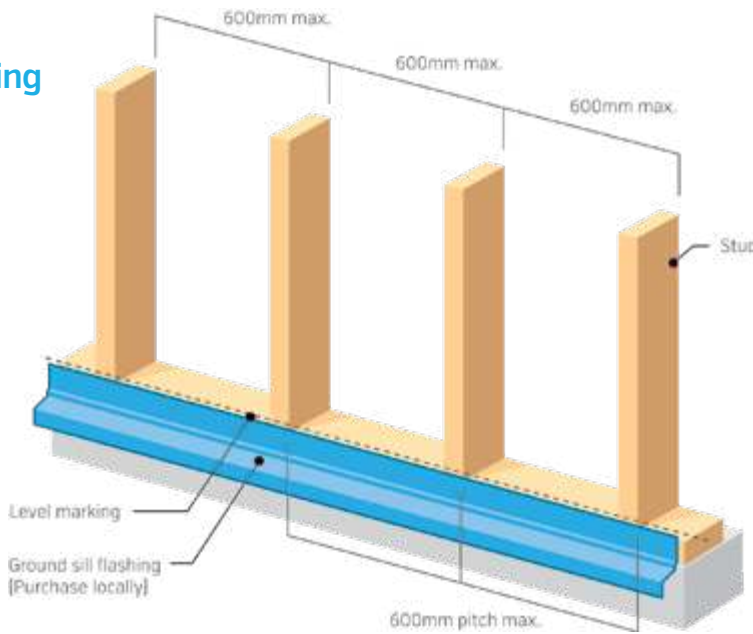

## 3. Sarking

### Adhesive tape & overlap of sarking

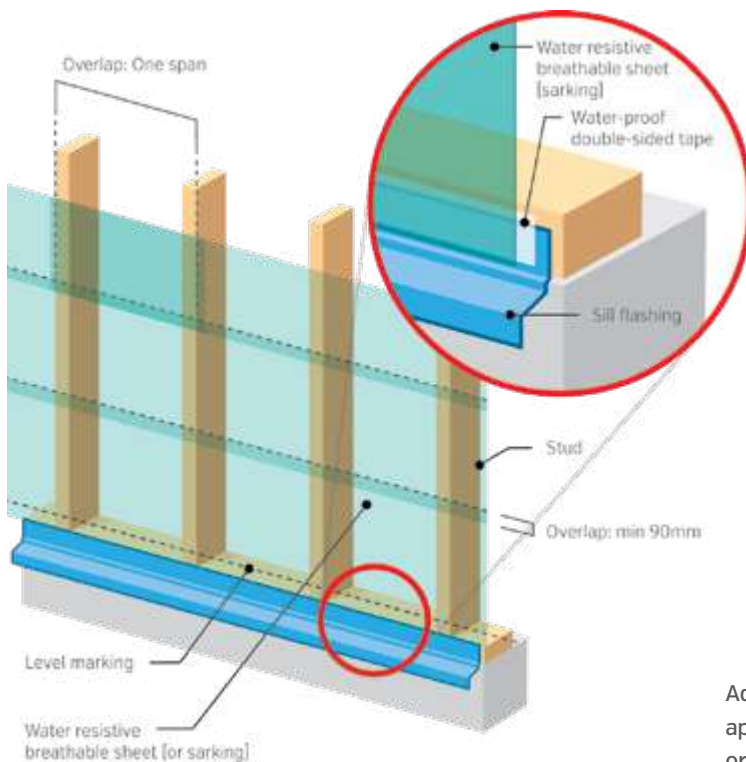

**Note:** use double-sided water-proof tape.

### Inside corner

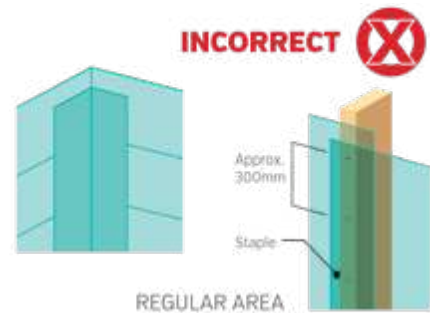
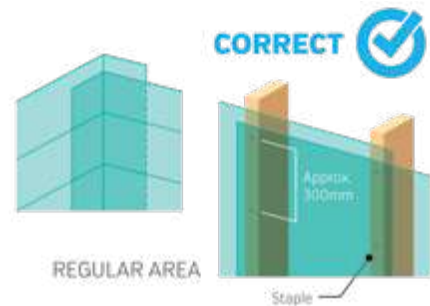

Adhesive tape application order around the window frame

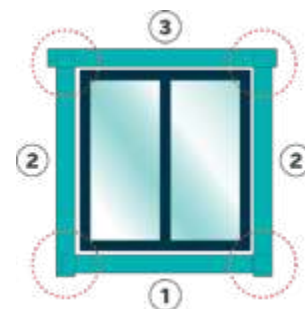

## 4. Marking

for starter bar 15mm

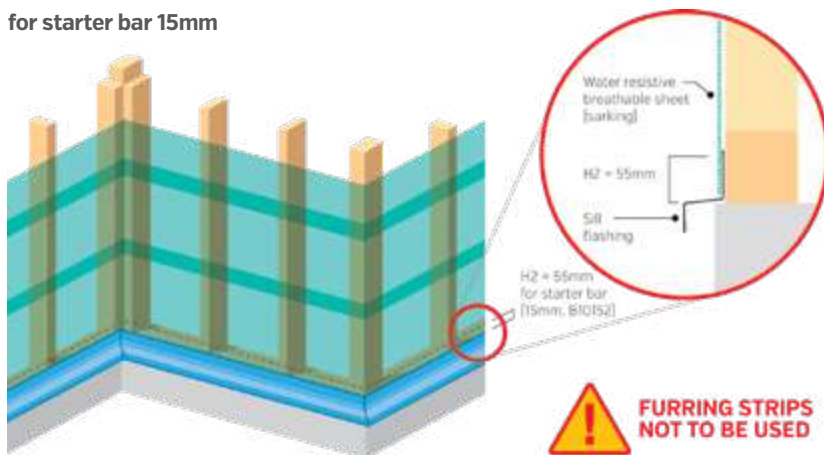

## 5. Accessories

### Hidden flashing

- Install additional studs to fix clips
- Install hidden flashings at the inside corners.

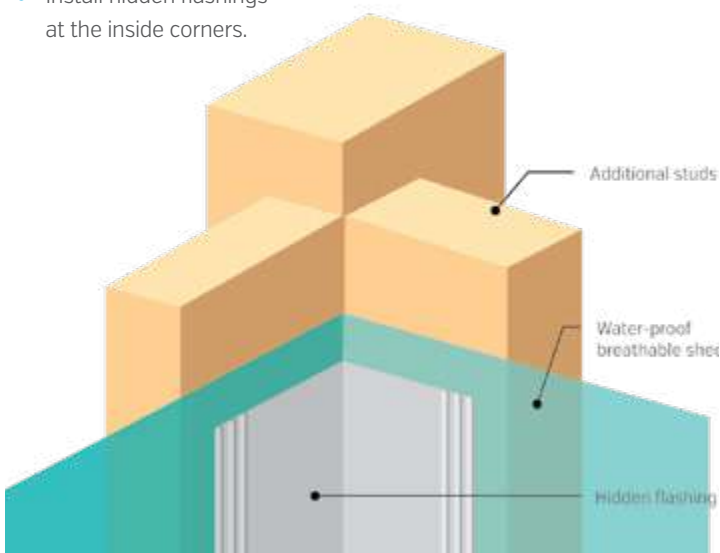

### Inside corner

Water running horizontally this direction will be stopped with the hat-shaped joiner.

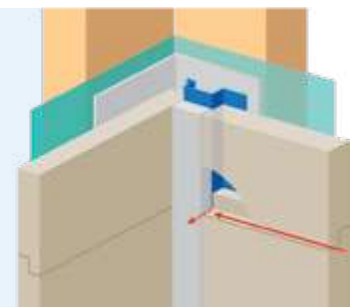

Water running horizontally this direction will get in the wall.

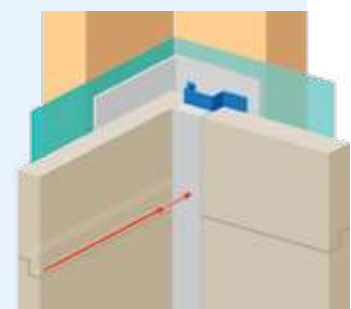



## 5. Accessories [continued]

### Starter bar

- With a level, starter bars are horizontal.
- Fix the starter bars with specific screws less than every 600mm.

15mm Starter Bar

Material: Hot-dipped zinc/aluminium coated steel with a polyester paint finish.

t = 0.8mm  
L = 3030mm

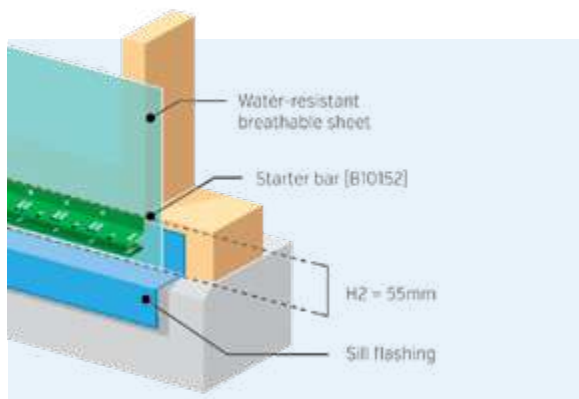

Outside corner

### Eave flashing (ventilation type)

- Carefully place spacers so as not to block the ventilation holes behind the eave flashing.
- Check flashing is horizontal with a level.
- Fix the flashing with nails or screws at intervals of 500mm or less.

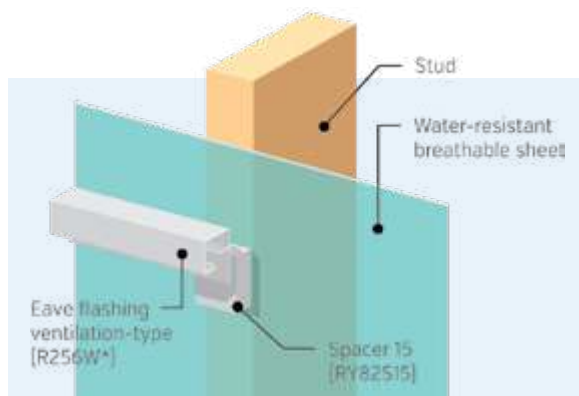

Eave

### Hat-shaped joiner (double sided type)

- Fix the hat-shaped joiners with nails or screws approximately every 1 metre or less to stop horizontal movement of the panels
- Install additional studs as necessary at the outside corners.
- Check the location of the joiner with corner sidings.

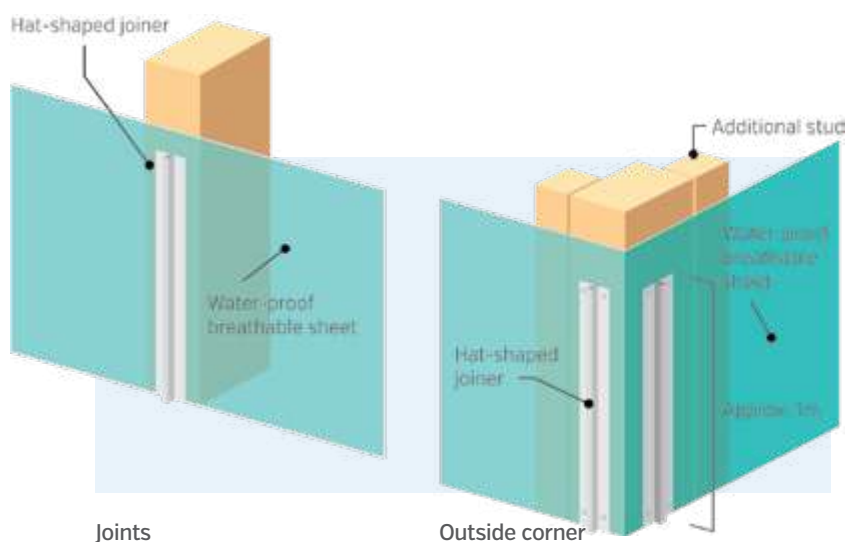

Joints

Outside corner

## 5. Accessories [continued]

### Hat-shaped joiner (one sided type)

- Fix the hat-shaped joiners with nails or screws approx. every **1 metre or less** to stop horizontal movement of the panels.

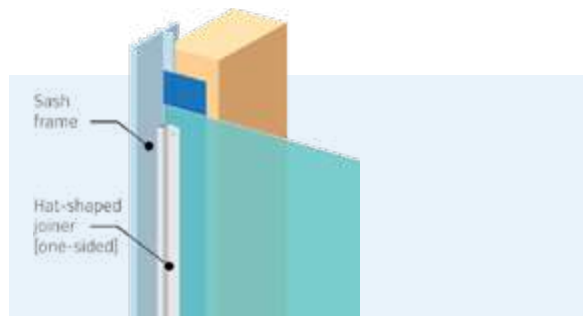

Openings

- After one side wall installed, install hat-shaped joiner.
- Fix the hat-shaped joiners with nails or screws approx. every **1 metre or less** to stop horizontal movement of the panels.

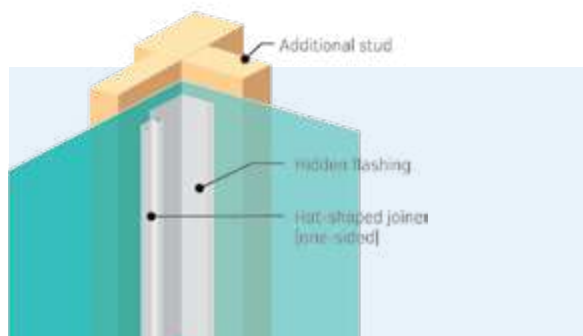

Inside corner

## 6. Measurement

- Take measurements of the siding to be cut.
- Measurements will be taken on the front of siding however cutting will be conducted the back side up. So please pay careful attention.

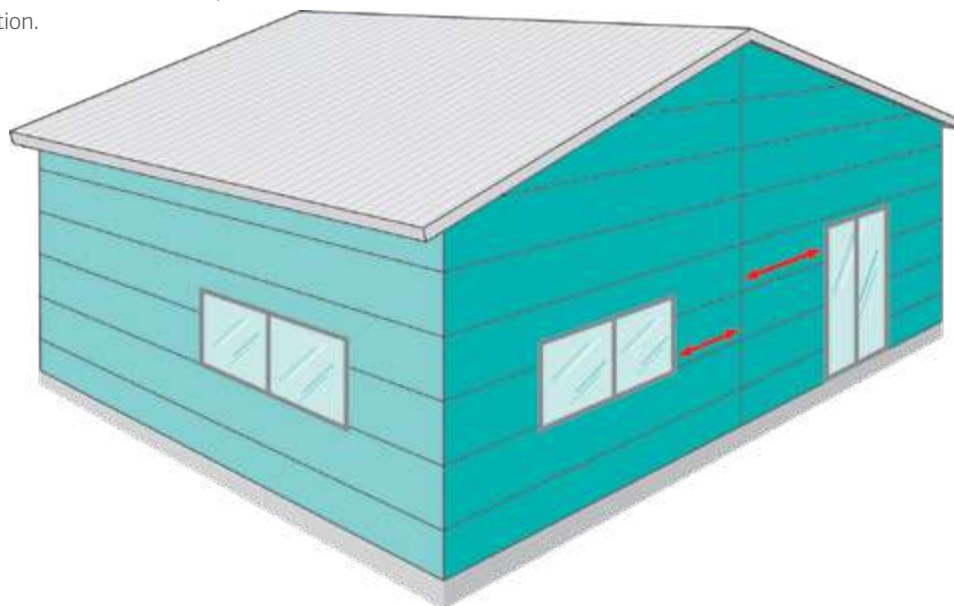

## 7. Cutting panels

 <p><b>Cutting equipment</b></p> <p>Circular saw with automatic dust collector (low circulation)</p>	 <p><b>Blade</b></p> <p>Diamond tipped</p>	 <p><b>Protection equipment</b></p> <p>Use a dust proof mask, eye protection and gloves. <b>DON'T USE LOOSE GLOVES.</b></p>	 <p><b>How to cut</b></p> <p>Cut from back side so as not to damage the pre coated front surface.</p>	 <p><b>Spacer</b></p> <p>When cutting a panel as shown below, use spacers which have sufficient thickness so as not to cut the panel/s underneath.</p>
---	---	--	---	---



If small pieces are installed below a wide opening, it is recommended to follow example B and separate the smaller section.

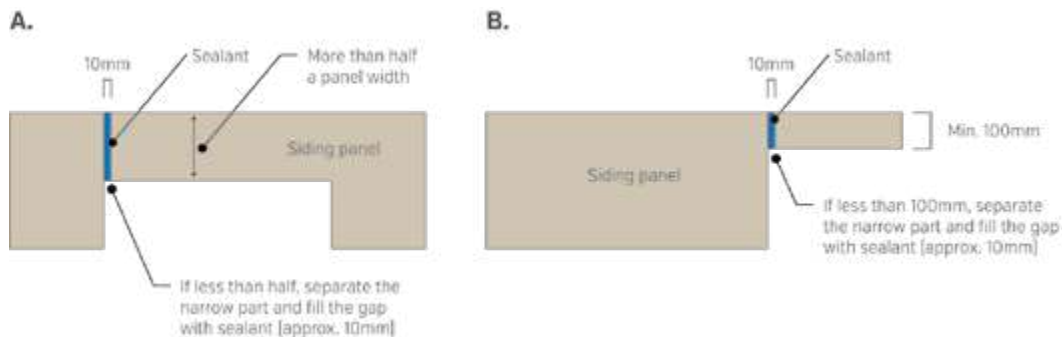

**Example A:** The finished width must be half or more the original panel width.

**Example B:** The finished width must be 100mm or more.

If the width becomes less than the above specification, separate the narrow part, and fill the 10mm gap with sealant.

- If the criteria is not followed, eventually cracks will be generated as shown on the pictures to the right.

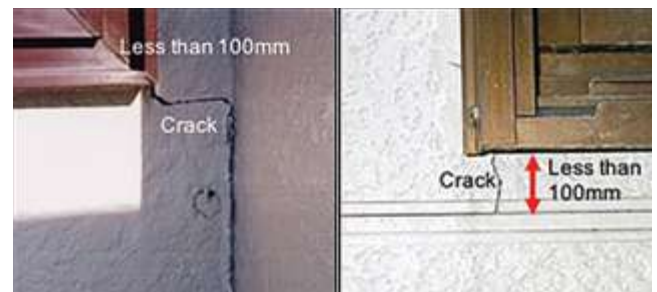

## 7. Cutting panels (continued)

### Treatment of panel cut surfaces

Portions that require sealer application

1. Roof lines
2. Flashings
3. Balconies and overhangs

Portions that don't require sealer application

- Vertical Joints
- Shiplapped Joints
- Sealant joints
- Any other cut edge that will be caulked.

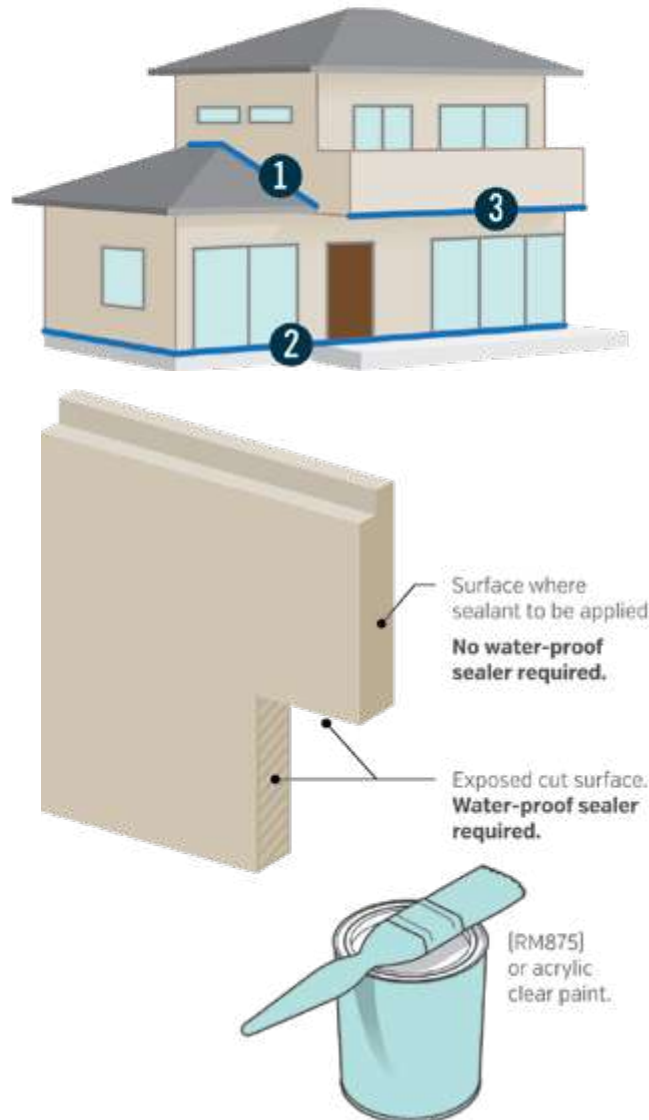

## 8. Opening details

### Window head horizontal

1. Waterproof breathable sheet.
2. Lintel.
3. Double-sided waterproof tape.
4. Specified screw.
5. Starter bar [B10152].
6. Z flashing.
7. Window frame.

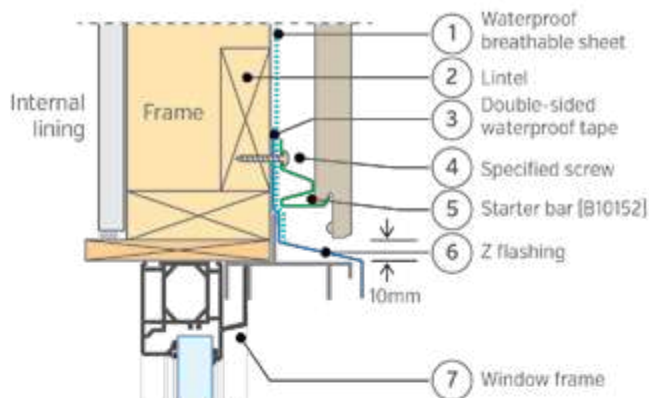

### Window head vertical

1. Waterproof breathable sheet.
2. Lintel.
3. Double-sided waterproof tape.
4. Specified screw.
5. Starter bar [B10152].
6. Z flashing.
7. Window frame.

### Window head vertical

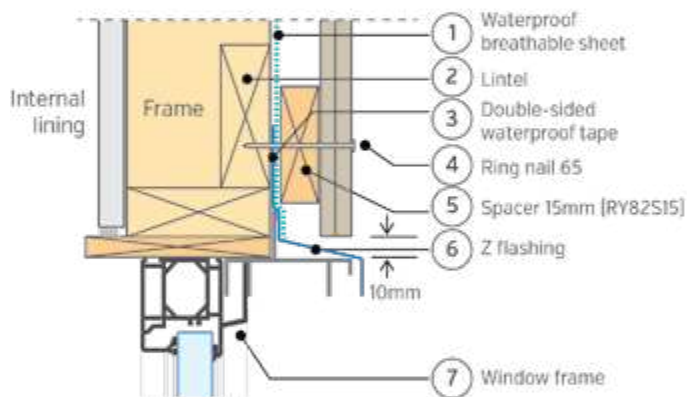

### Window sill

1. Waterproof breathable sheet.
2. Spacer 15mm [RY82S15].
3. Sealant.
4. Apron flashing.
5. Ring nail 65.
6. Double-sided waterproof tape.

### Window sill

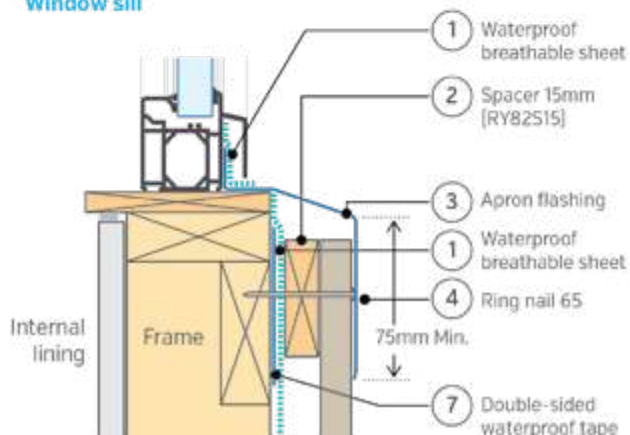

## 8. Opening details [continued]

### Window jamb horizontal

1. Window frame.
2. 2 piece and profile.
3. Ring nail 65.
4. Double-sided waterproof tape.
5. Foam packer [Kmew].
6. Waterproof breathable sheet.

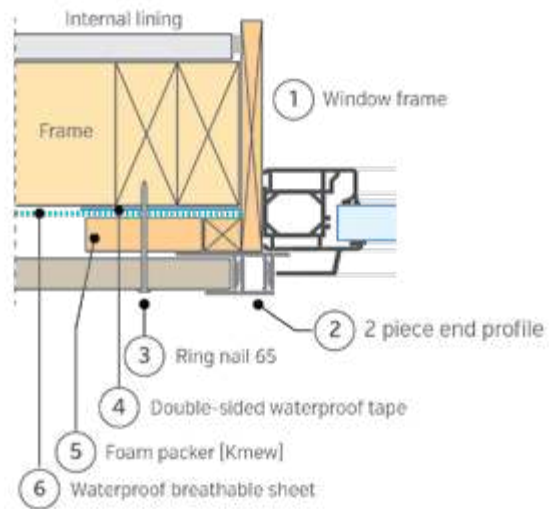

### Window jamb vertical

1. Window frame.
2. 2 piece and profile.
3. Ring nail 65.
4. Double-sided waterproof tape.
5. Foam packer [Kmew].
6. Waterproof breathable sheet.

### Window jamb detail vertical

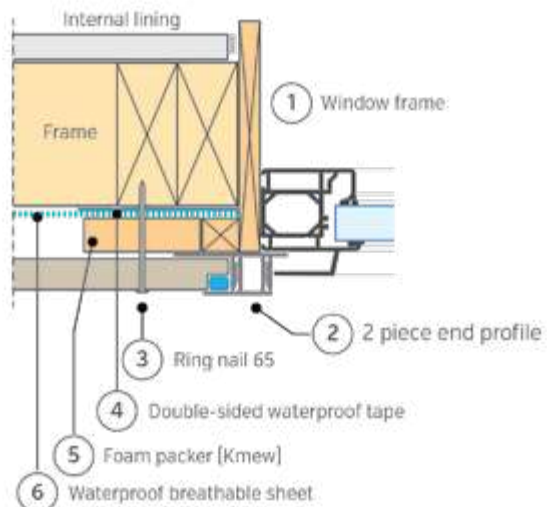

## 8. Opening details [continued]

### Door jamb vertical

1. Sealant.
2. Water-resistant breathable sheet.
3. 2 piece end cover.
4. Ring nail 65.
5. Door jamb timber reveal.
6. Double-sided waterproof tape.
7. Door frame.
8. Sill flashing.

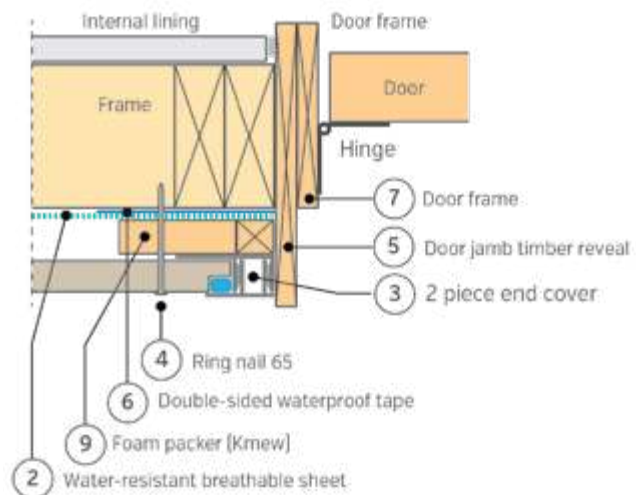
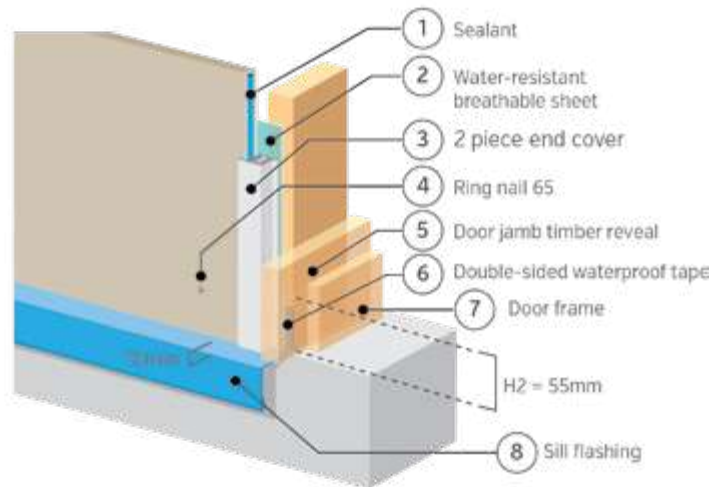

## 8. Opening details [continued]

### Wall run expansion gaps vertical and horizontal

1. Framework.
2. Sarking.
3. Timber batten.
4. Join profile.
5. #10 Specified screw.
6. Cera Façade panel.
7. Weather-proof strip.

### Wall returns

1. Frame.
2. Sarking.
3. Cera Façade panel.

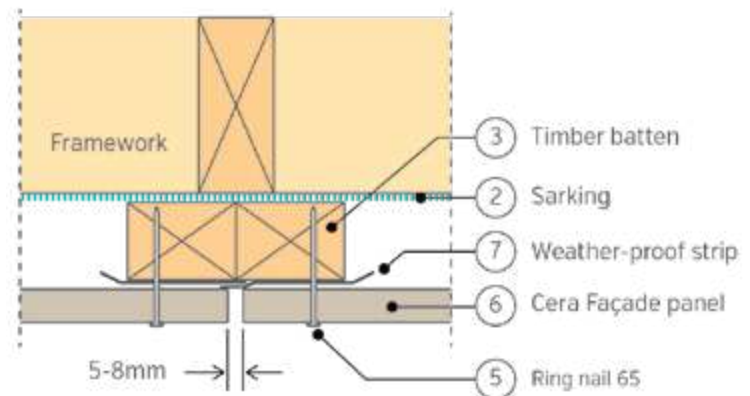
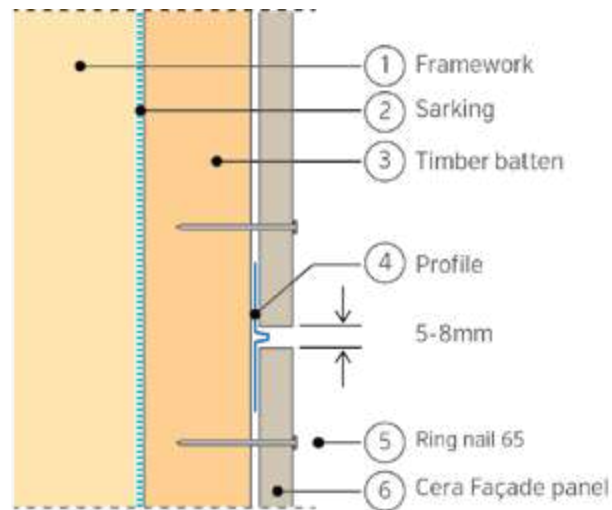

### Bulkhead return details

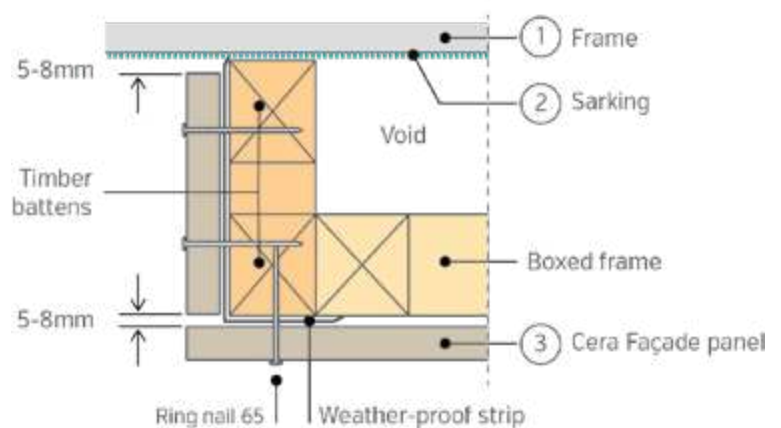



## 9. Fixing panels horizontally

The following instructions demonstrate horizontal installation. For vertical installation see page 16.

### How to fix panels Horizontally with 15mm clips

- Panels must be fixed from bottom to top.
- Maintain 10mm gap between the sill flashing and siding.
- Use the clips to fix the panels and corner sidings.
- For eave and opening portions, insert 15s spacers, pre-drill pilot holes (approx.Ø2mm) 25-35mm from the edge of the panel, and fix with ring nail 65.

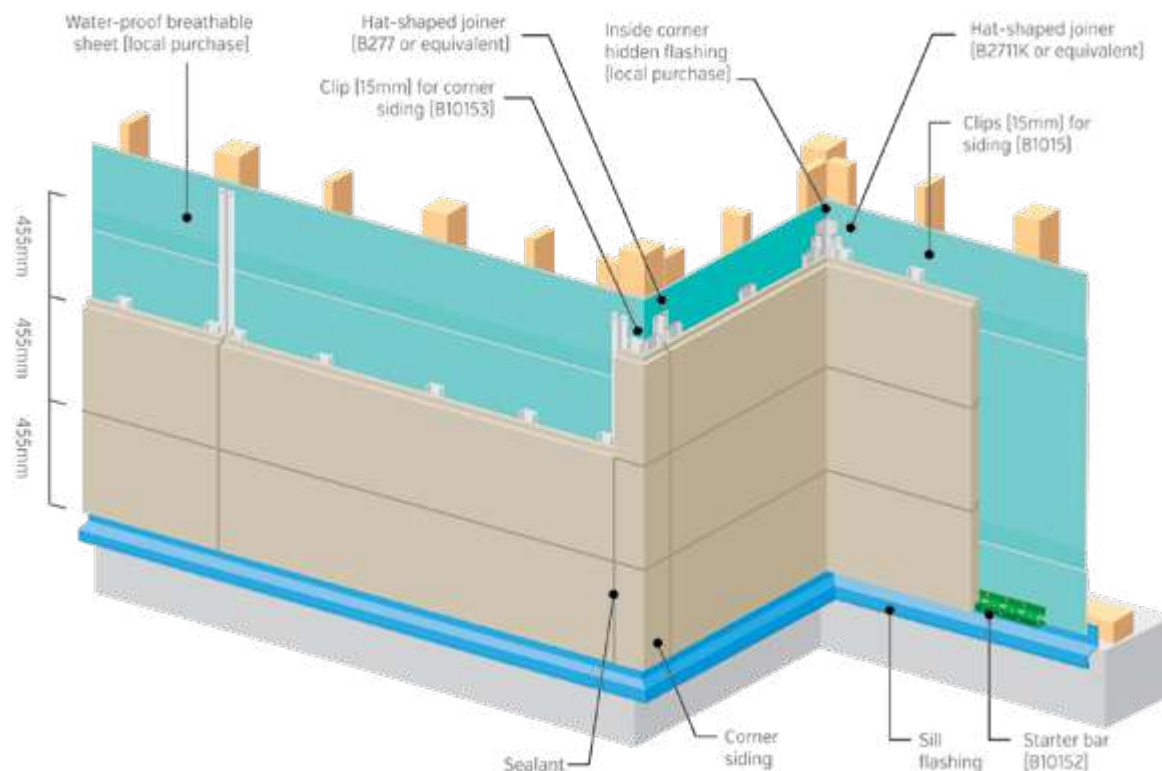

### Sill

- Check the horizontal level for each layer of the panels.
- Make sure that there are 10mm gaps between the sill flashings and siding panels.

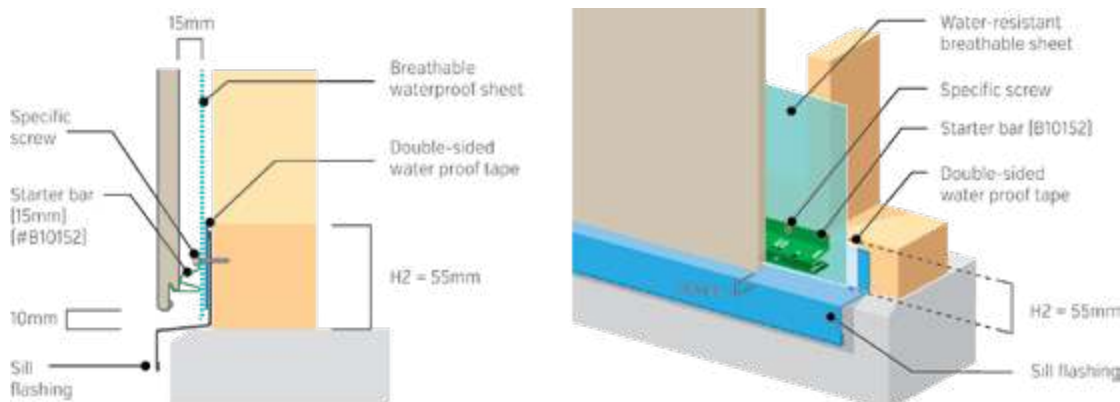

## 9. Fixing panels horizontally [continued]

### Clips for panels

- Clips for panels must be fixed every 600mm or less to pillars or studs.
- Fix a clip with a specific screw.
- First use the center hole. If it doesn't work, use one of the other two holes.

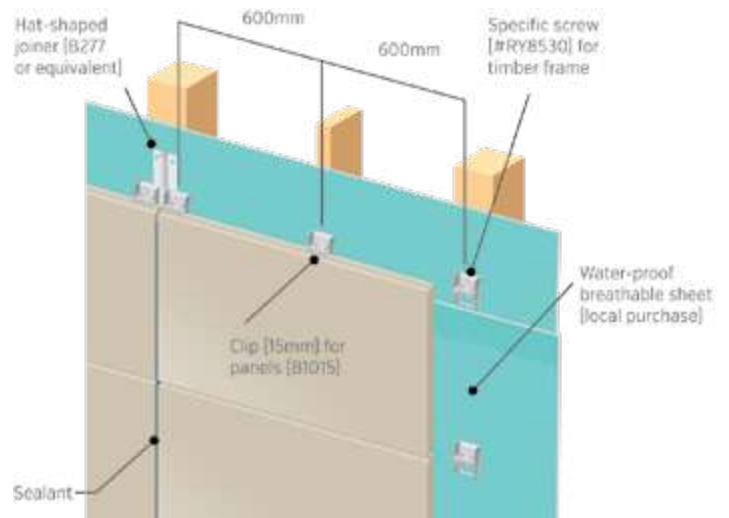
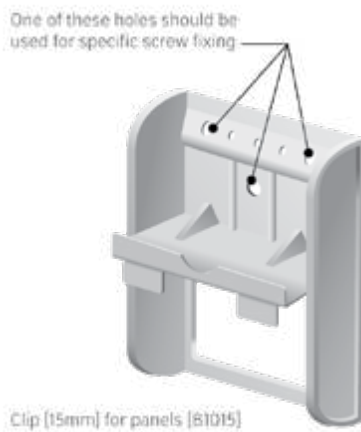

### Vertical joints

- Fix clips right and left of the hat-shaped joiner.
- Clips can be placed on the fringe of the double-sided joiner.

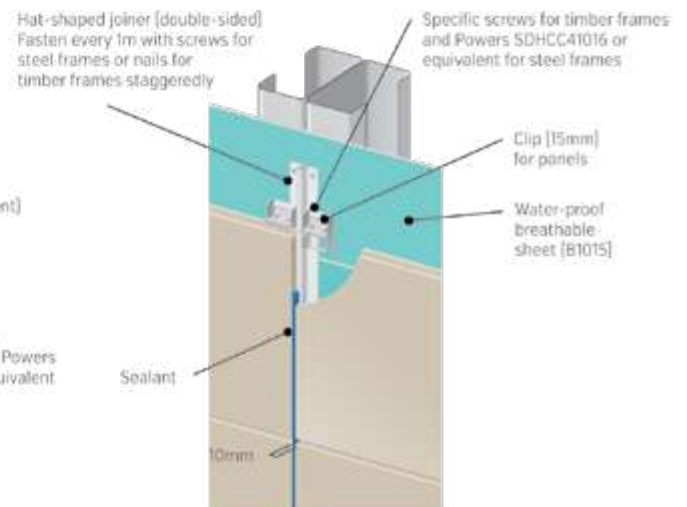
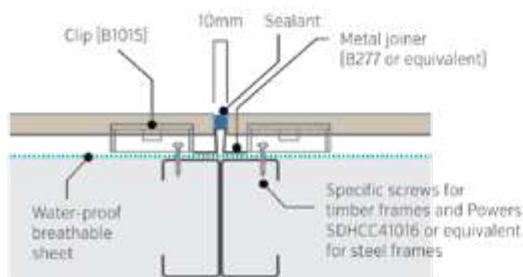

The manufacturer recommends the water-proof beatheable sheet even for the steel frames. The risk of condensation will become higher in the stud cavity if non-beatheable (non vapor permeable) sheet is used. The condensation in the stud cavity may make the steel studs rotten in the long run. With a water-proof beatheable sheet the vapor from the inside can reach to the air cavity where air and vapor will be exhausted out. We strongly recommend to use a water-proof beatheable sheet.

## 9. Fixing panels horizontally (continued)

### Inside corner

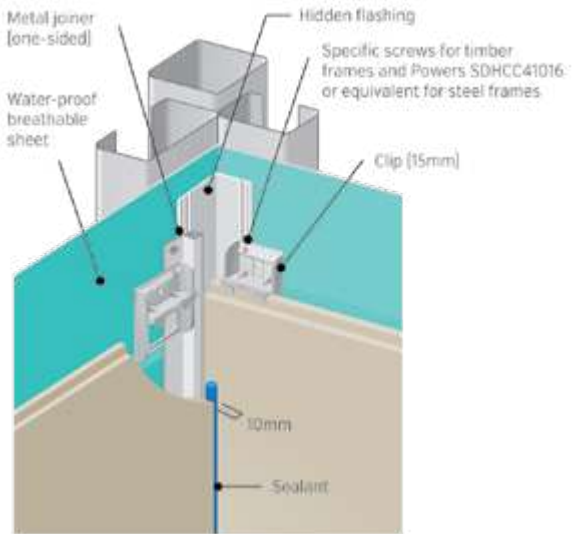
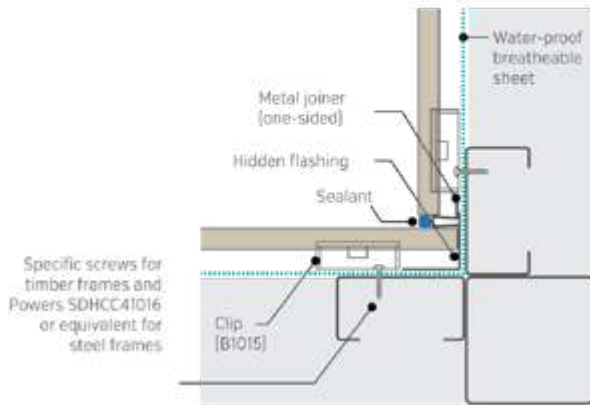

### outside corner

- Fix two corner clips.

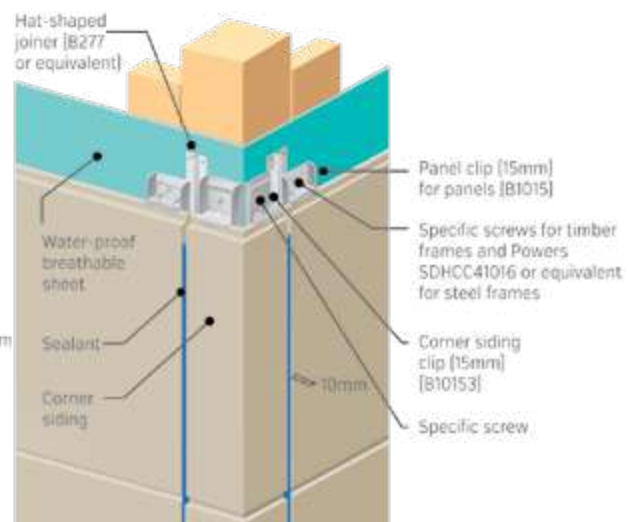
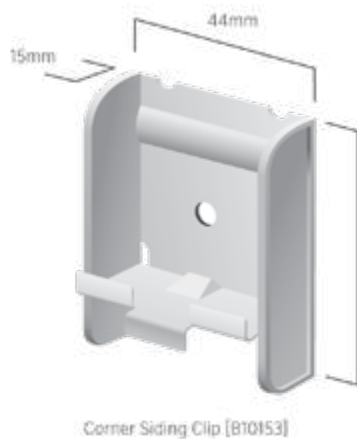

Corner siding

### Metal corner

- Fix with nails or screws using furring strips or spacer (15mm thick).

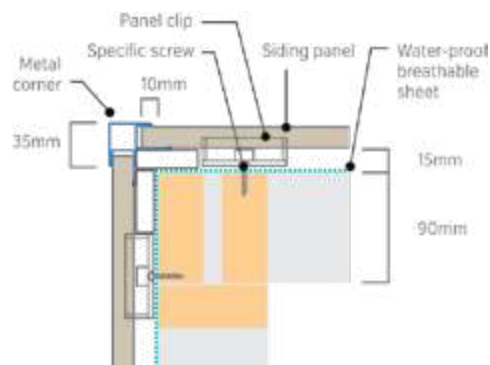

## 9. Fixing panels horizontally [continued]

### Opening

- Use spacer 15s for opening upper and lower parts. Pre-drill pilot holes (approx.Ø2mm) 25–35mm from the edge of the panel, and fix with nails or screws.

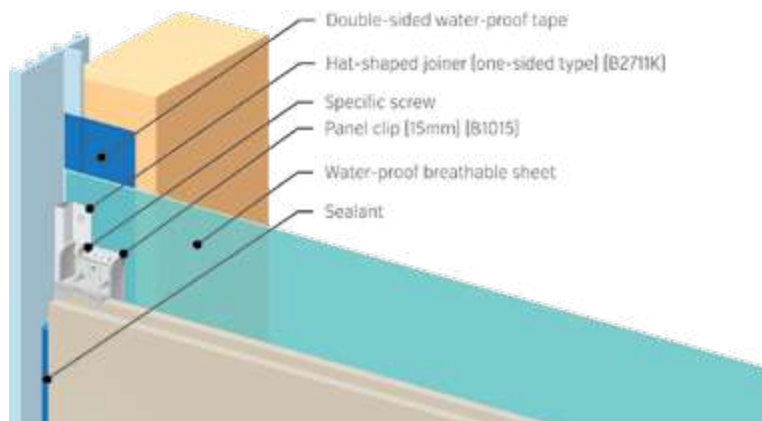

Sides

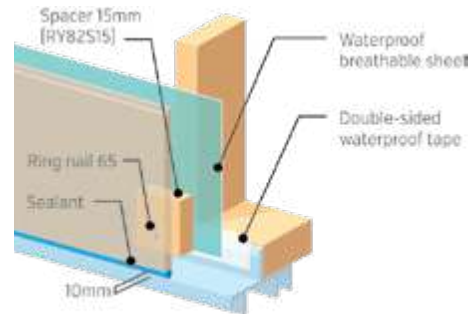

Upper part

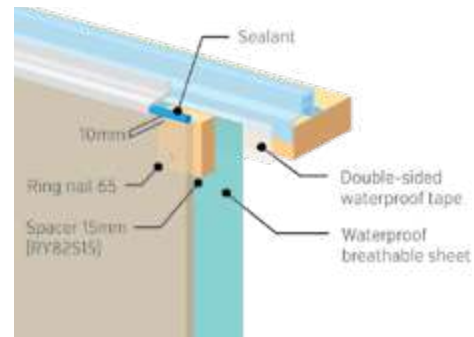

Lower part

### Eave

- At eave portion, use spacer 15s, pre-drill pilot holes (approx.Ø2mm) and fix with nails or screws.

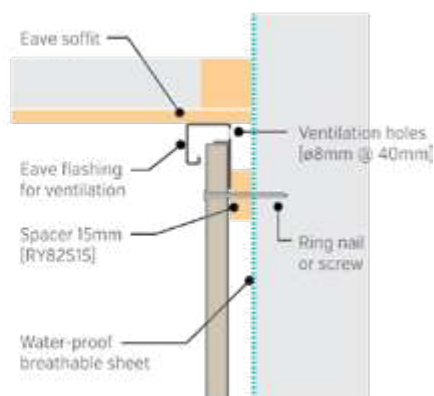
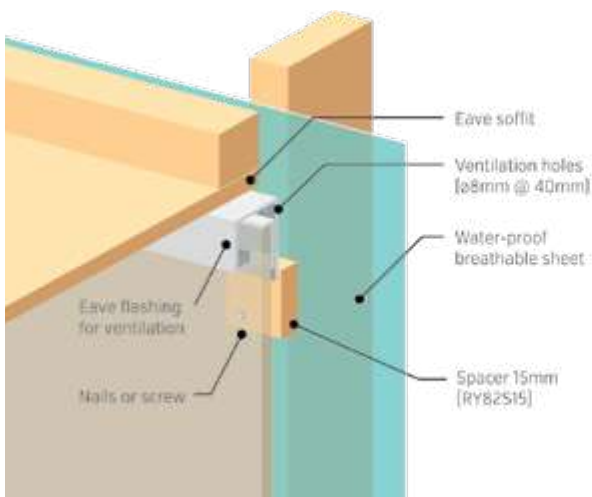

## 9. Fixing panels horizontally (continued)

Roof (horizontal)

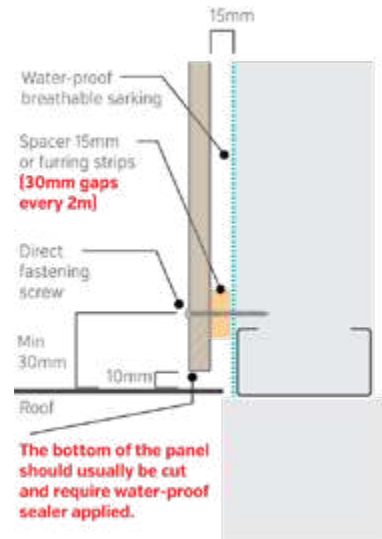

Roof (sloped)

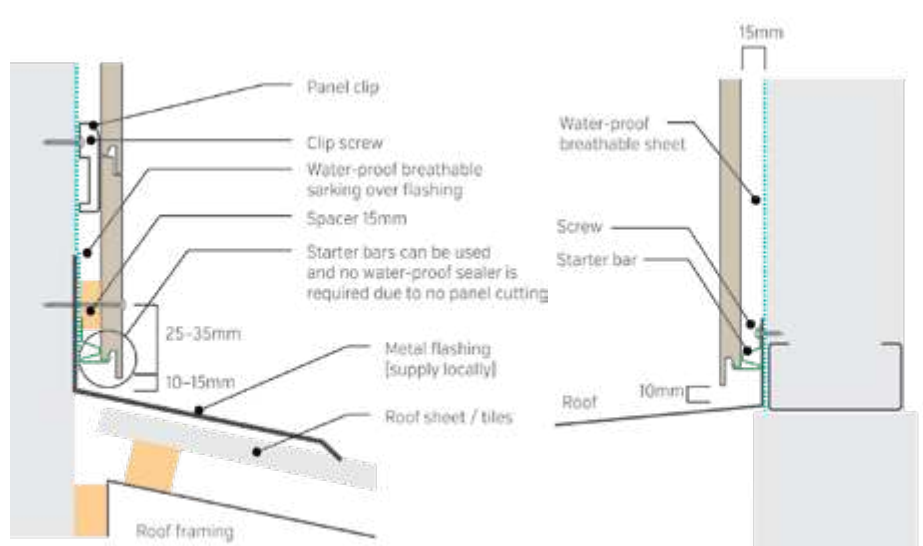

## 10. Fixing panels vertically [continued]

### How to fix panels vertically with 15mm clips

- Panels must be fixed from bottom to top.
- Maintain 10mm gap between the sill flashing and siding.
- Use the clips to fix the panels and corner sidings.
- For eave and opening portions, insert 15s spacers, pre-drill pilot holes (approx.Ø2mm) 25-35mm from the edge of the panel, and fix with ring nail 65.

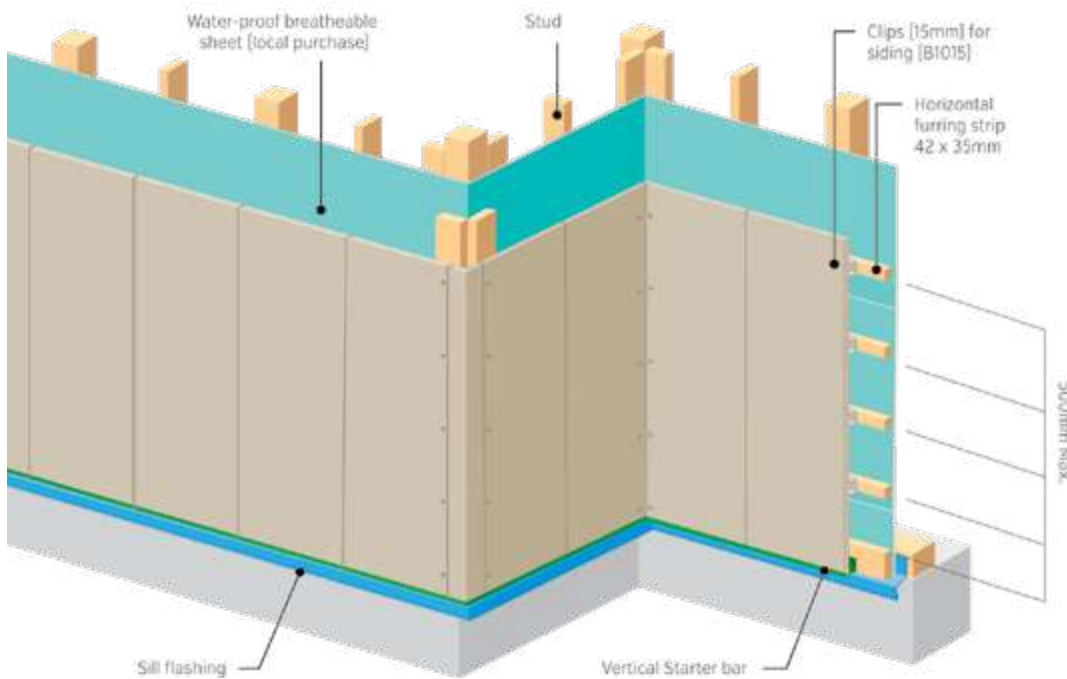

### Base of wall

- Check the horizontal level for each layer of the panels.
- Make sure that there are 10mm gaps between the sill flashings and siding panels.



### Note!

Must be designed for specific windloads.

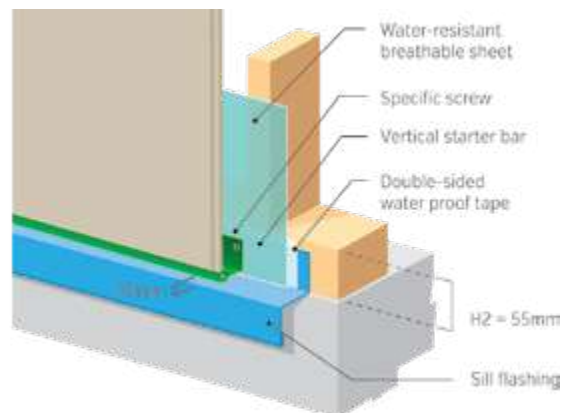
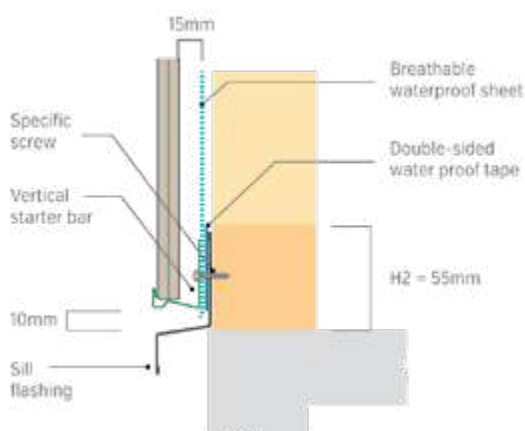

## 10. Fixing panels vertically [continued]

### Clips for panels

- Clips for panels must be fixed every 600mm or less to pillars or studs.
- Fix a clip with a specific screw.
- First use the center hole. If it doesn't work, use one of the other two holes.

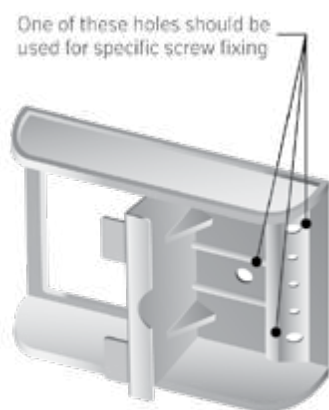

Vertical Clip [15mm] for panels [B1015]

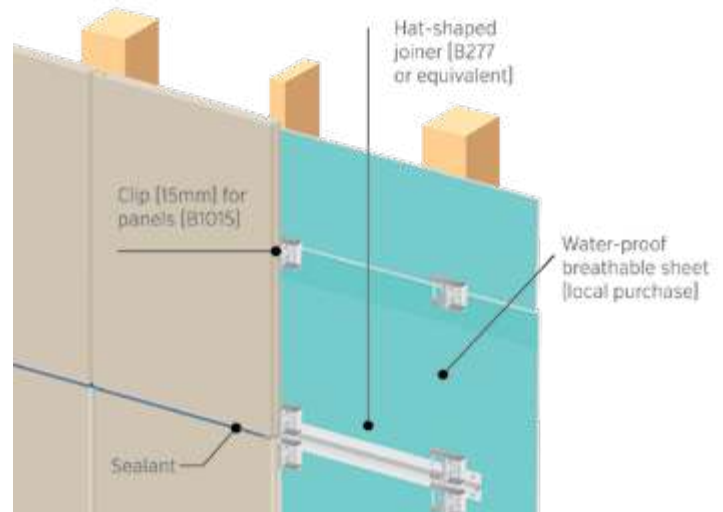

### Vertical joints

- Fix clips above and below the hat-shaped joiner.
- Clips can be placed on the fringe of the double-sided joiner.

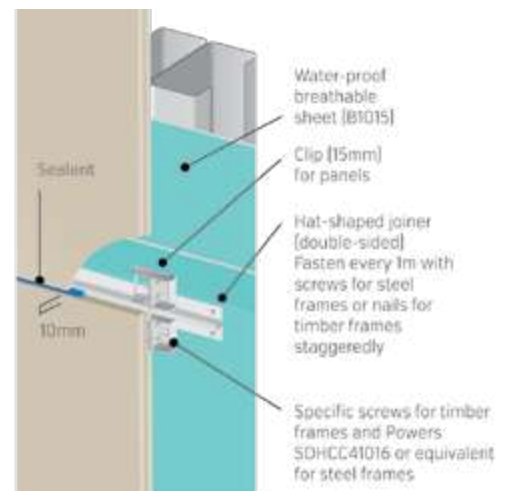
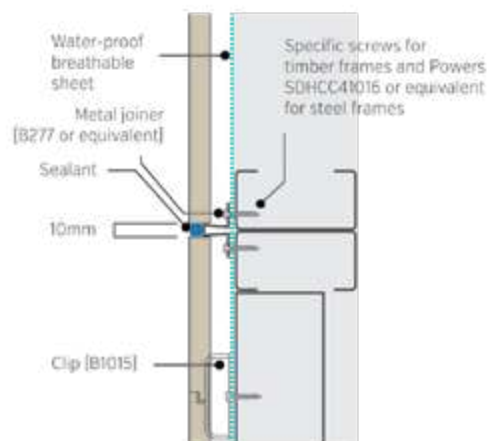

The manufacturer recommends the water-proof beatheable sheet even for the steel frames. The risk of condensation will become higher in the stud cavity if non-beatheable (non vapor permeable) sheet is used. The condensation in the stud cavity may make the steel studs rotten in the long run. With a water-proof beatheable sheet the vapor from the inside can reach to the air cavity where air and vapor will be exhausted out. We strongly recommend to use a water-proof beatheable sheet.

## 10. Fixing panels vertically [continued]

### Inside corner

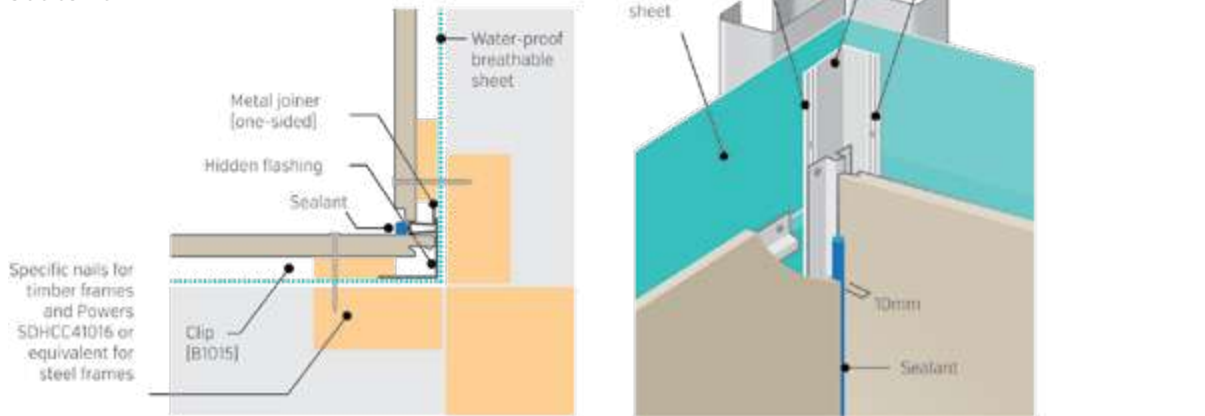

### outside corner

- Fix two corner clips.

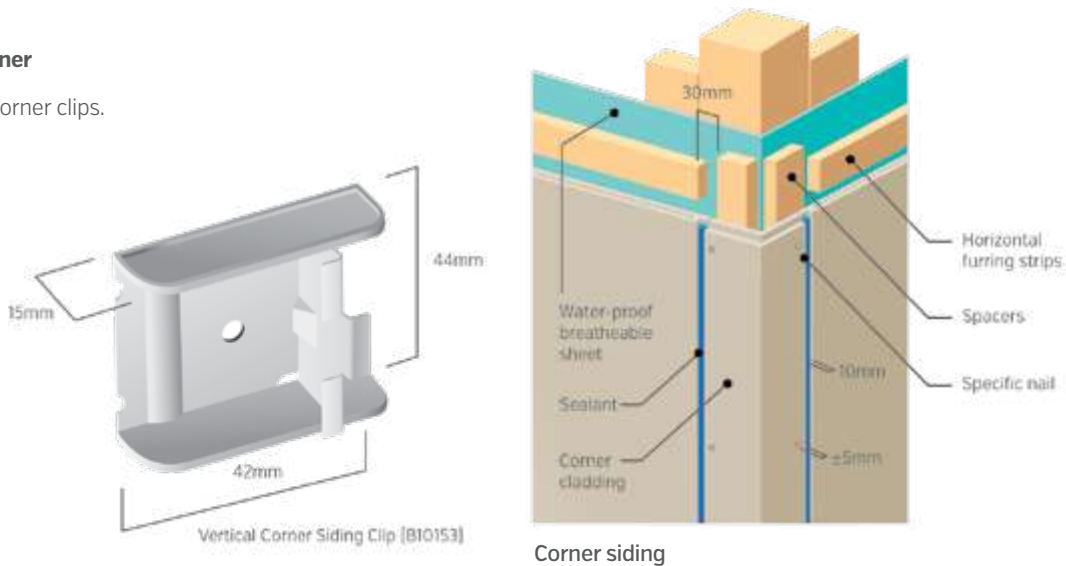

### Metal corner

- Fix with nails or screws using furring strips or spacer (15mm thick).

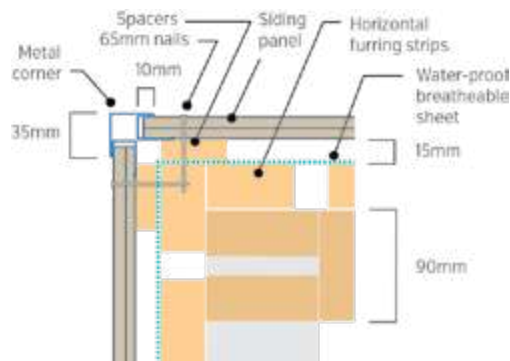



## 10. Fixing panels vertically [continued]

### Opening

- Use spacer 15s for opening upper and lower parts. Pre-drill pilot holes (approx.Ø2mm) 25–35mm from the edge of the panel, and fix with nails or screws.

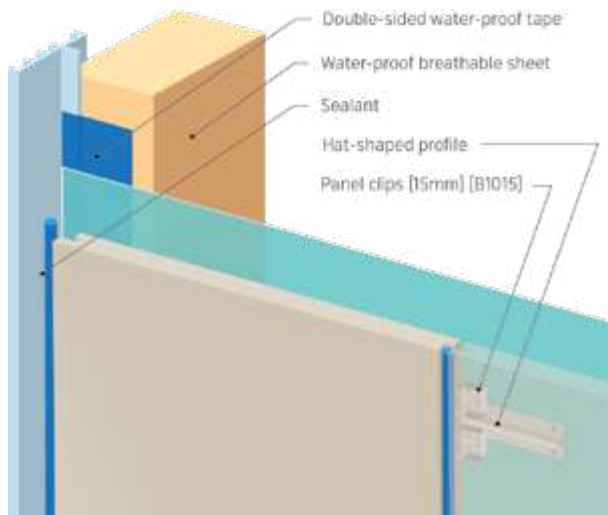

Sides

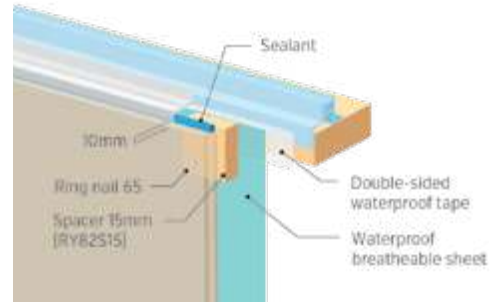

Upper part

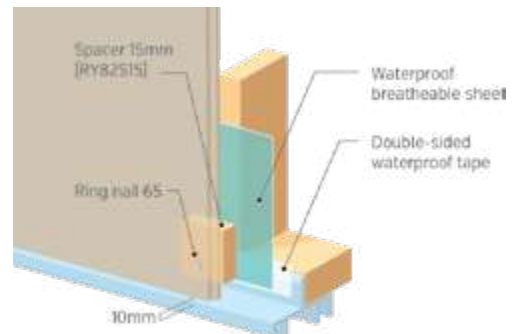

Lower part

### Eave

- At eave portion, use spacer 15s, pre-drill pilot holes (approx.Ø2mm) and fix with nails or screws.

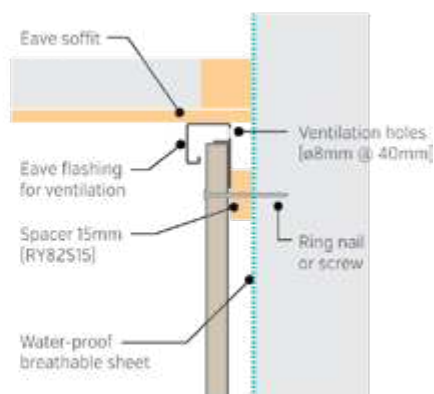
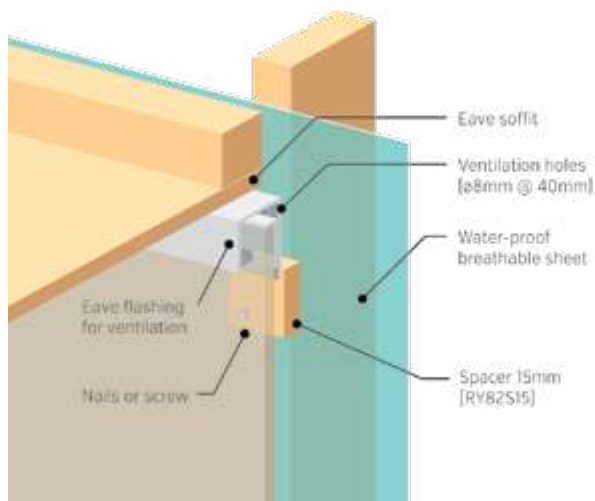

## 10. Fixing panels vertically (continued)

Roof (horizontal)

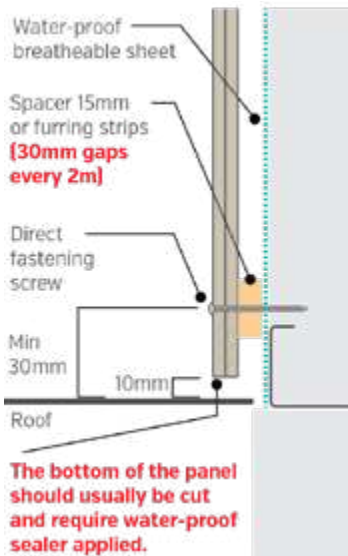

Roof (sloped)

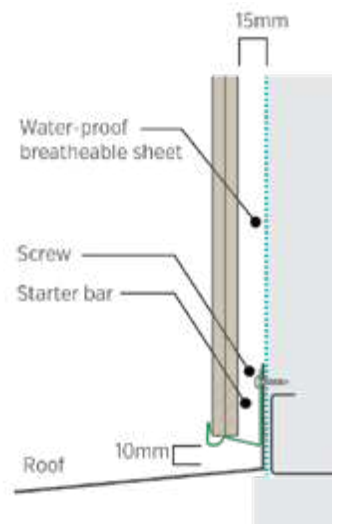
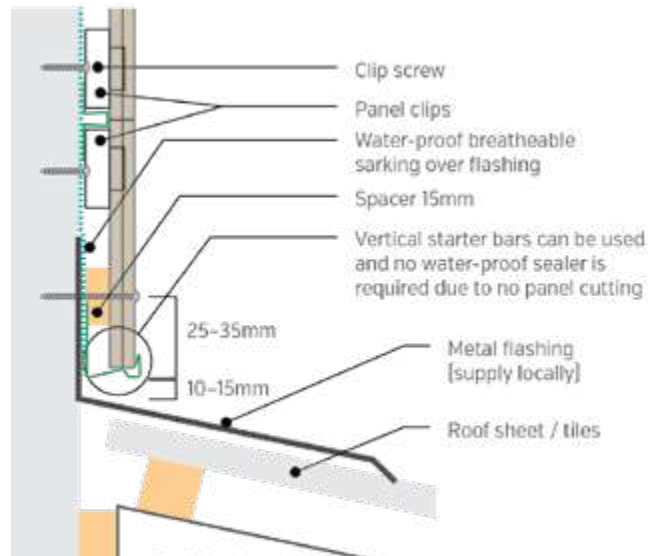

## 11. Available flashings

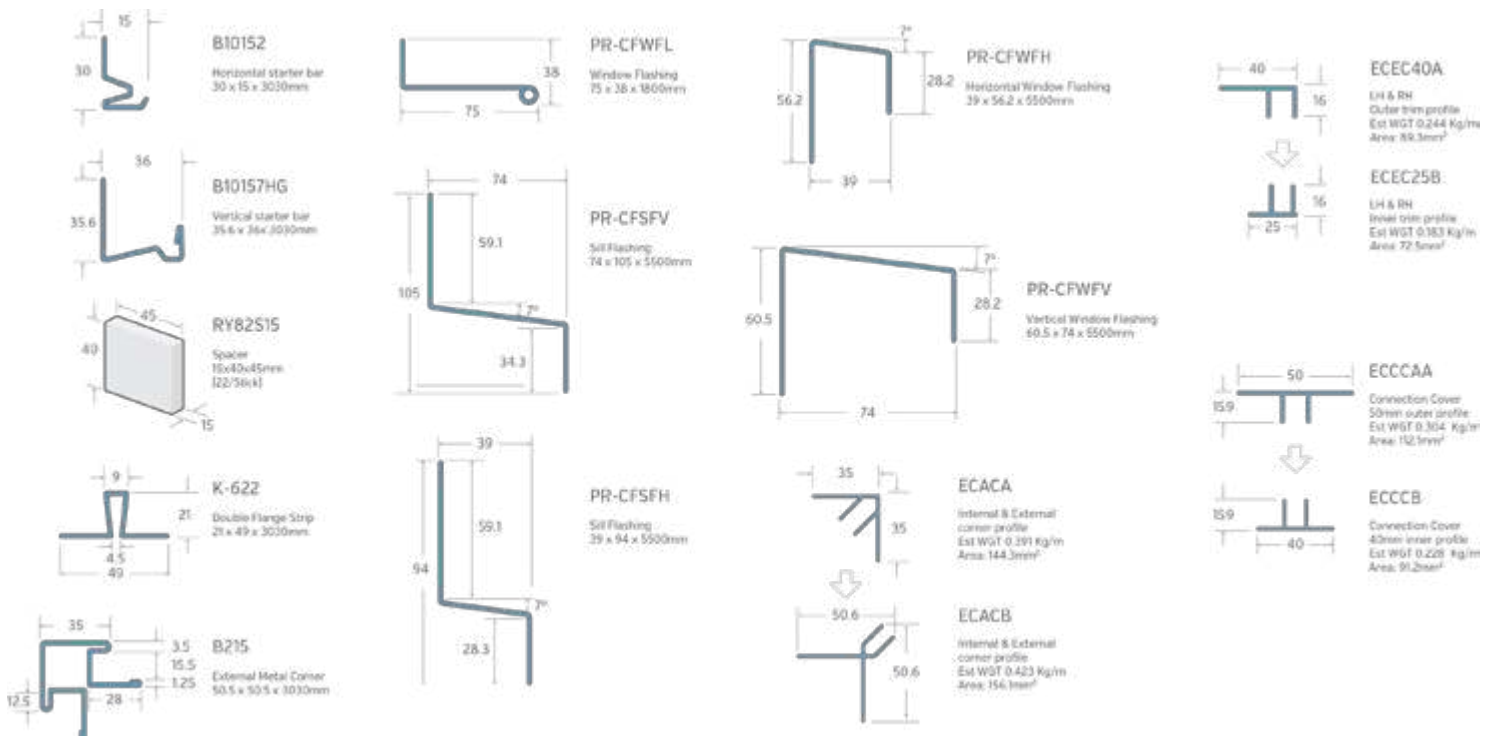





## 12. Touch up paint



### Very Important

- Paint should be finished within the same day of mixing the paint ingredients. If the application cannot be completed within the same day, be sure to finish painting within 24 hours of applying the primer.
- Failure to follow the procedures below can result in poor colour matching and may cause repaired portions to discolour over time.

ORDER	CONTENT OF WORK	IMAGES
1. Preparation	<ul style="list-style-type: none"> <li>• Ensure that the siding surface is completely dry. Avoid painting when it is rainy and wet or the temperature is 5°C or less.</li> <li>• Clean areas to be painted.</li> </ul>	 <p>Red label: Primer      Blue label: Paint Base      Green label: Hardener</p>  <p>Brushes</p>
2. Mixing of touch-up paint	<ul style="list-style-type: none"> <li>• Pour the entire bottle of hardener into the base paint bottle. Shake the bottle well.</li> <li>• The mixed paint is susceptible to air humidity. Be sure to close the lid tightly after mixing.</li> <li>• The mixed paint should be used after 30 minutes and within 8 hours of mixing.</li> </ul>	 <p>Hardener</p> <p>Put all of the hardener into the paint base bottle.</p> <p>Paint Base</p>  <p>Shake the bottle well until paint color becomes even.</p>
3. Primer application	<ul style="list-style-type: none"> <li>• Avoid dripping during application. In case of dripping, remove it immediately with a clean cloth.</li> <li>• The primer is susceptible to air humidity; be sure to close the lid tightly after use.</li> <li>• For best results, apply sparingly.</li> </ul>	 <p>APPLY THE PAINT CAREFULLY TO PREVENT DRIPPING</p>
4. Drying	<ul style="list-style-type: none"> <li>• Allow 30 minutes for the primer to dry.</li> </ul>	

## 12. Touch up paint [continued]

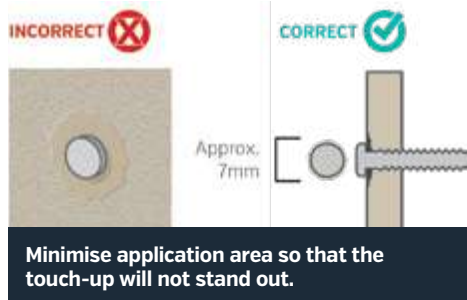
ORDER	CONTENT OF WORK	IMAGES
5. Application of touch-up paint	<ul style="list-style-type: none"> <li>The mixed paint should be used after 30 minutes and within 8 hours of mixing.</li> <li>Use the included brushes to apply the paint without dripping.</li> <li>Apply the paint over portions applied with the primer.</li> <li>Apply the paint within 24 hours after applying the primer.</li> </ul>	
6. Inspection	<ul style="list-style-type: none"> <li>Check for uncoated sections.</li> <li>Paint as needed.</li> </ul>	

## 13. Sealant

### Application order

**1** 

Check weather before applying sealant.

**2** 

Clean the target joints.

**3** 

Fill joints with a backup material.

**4** 

Attach masking tape.

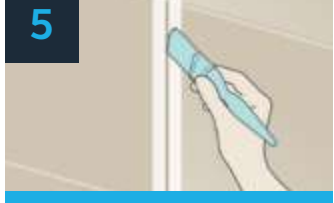
**5** 

Apply primer.

**6** 

Caulk the joints.

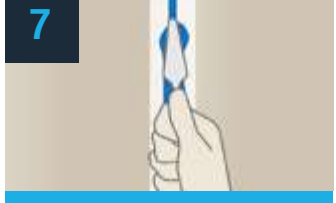
**7** 

Skim the surface.

**8** 

Remove the masking tape. This should be conducted before sealant is dry.

**9** 

Clean. This should be conducted after sealant is dry.

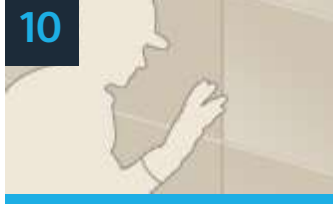
**10** 

Check the finish.

**NOTE:** No need to fill the joints with a backup material if metal joiners with bond breaker are used.

## 13. Sealant [continued]

- Apply masking tape according to the panel profile carefully.
- Don't use masking tape with a strong adhesion as it may remove the coating of the siding panels.

Keep Sealant width and depth as shown:

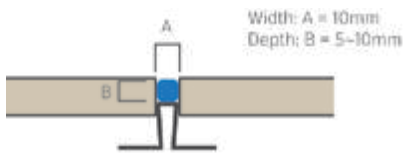

Use the joiner with bond breaker to avoid 3 surface adhesion

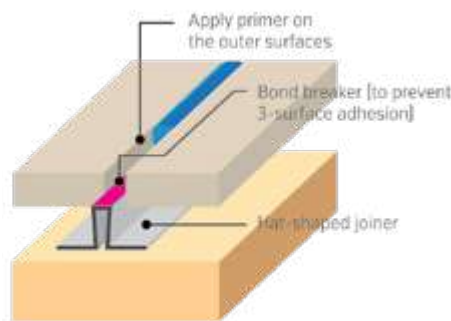

Apply Primer evenly on the cut surface of siding panels.

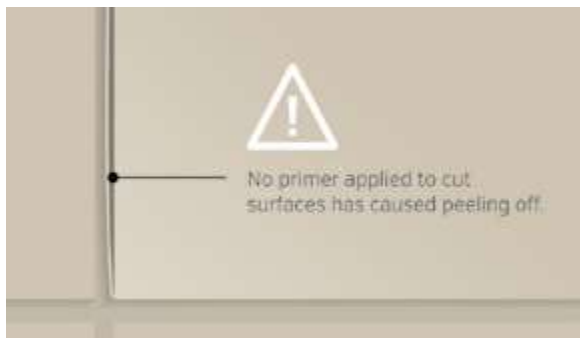

Use hat-shaped joiner for horizontal installation with clips to prevent panel horizontal movement.



### Very Important!

Primer needs to be applied prior to sealant → Without primer, sealant will easily peel off after a short time.  
Sealant should be applied around the pipes.

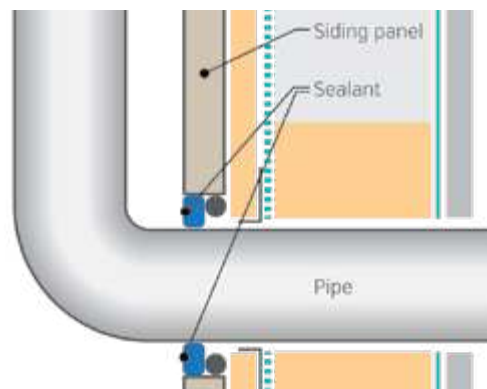
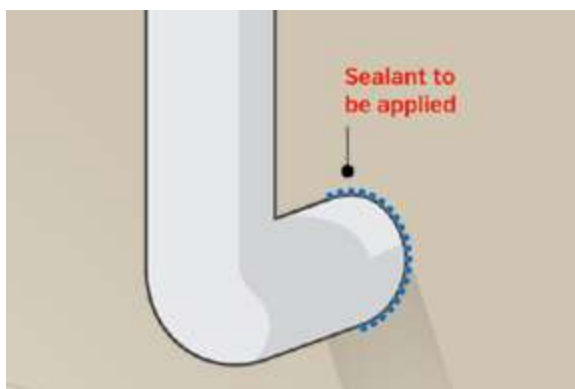

## 14. Replacing a panel

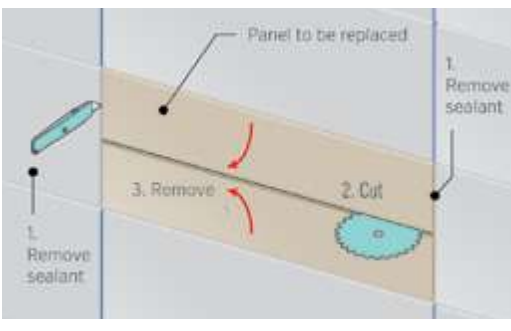
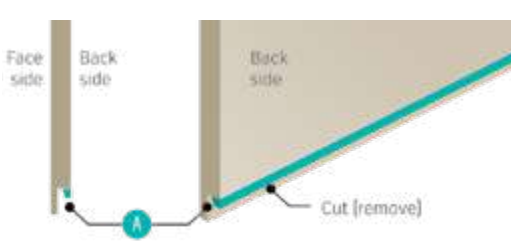
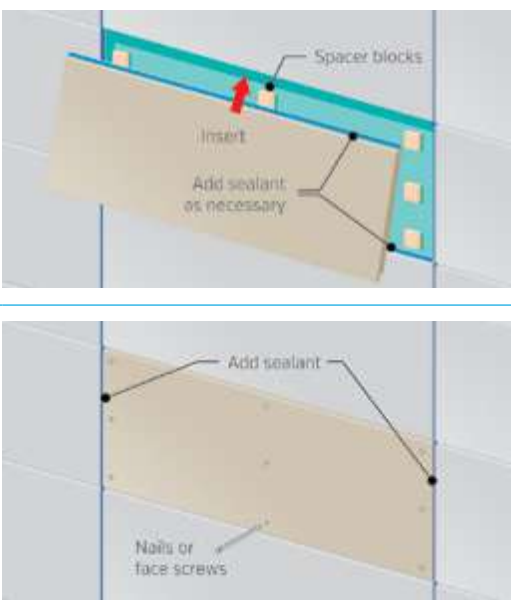
ORDER	CONTENT OF WORK	IMAGES
<p>1. <b>Remove</b></p>	<ul style="list-style-type: none"> <li>Use a utility knife to remove sealant around the panel.</li> <li>Cut the center of the panel with a power saw and remove the panel.</li> </ul> <p><b>Be careful not to damage the sheathing, waterproof building sheet, and adjacent panels.</b></p>	
<p>2. <b>Prepare the replacement panel.</b></p>	<ul style="list-style-type: none"> <li>Remove the part A (figure, right) of the replacement panel. Without removing this portion of the shiplapped edge the replacement panel will not fit.</li> </ul>	
<p>3. <b>Installation</b></p>	<ul style="list-style-type: none"> <li>Apply sealant to shiplapped edges to ensure a waterproof seal.</li> <li>Attach spacer blocks where the panel will be nailed (or screwed).</li> <li>Insert the replacement panel.</li> <li>Pre-drill pilot holes and nail or screw the panel into place.</li> <li>Apply touch-up paint to the nail or screw heads.</li> <li>Replace the sealant where it has been removed.</li> </ul>	

## 15. Health precautions



### Very Important!

When cutting the panels, prolonged inhalation of a large amount of dust may be harmful to your health. Please use the follow precautions:

- Use a vacuum saw with built in dust collection.
- Wear a dustproof mask and dustproof glasses.
- Work in a well-ventilated location.
- Make sure to wash your hands.



## Like what you see?

Get in touch and order your free sample today!

**Phone** 1800 156 455 **Email** [sales@urbanline.com.au](mailto:sales@urbanline.com.au)

For further product information and downloads

**Visit** [urbanline.com.au](http://urbanline.com.au)

**Phone** 1800 156 455 **Email** [sales@urbanline.com.au](mailto:sales@urbanline.com.au)

For further product information and downloads **Visit** [urbanline.com.au](http://urbanline.com.au)

PART OF THE **modinex** GROUP