



Cedar & Hemlock

PRODUCT LISTING



DAR Western Red Cedar



Beachclad Channel Cladding

Modinex makes it easy to create spaces that delight – inside and out.

At Modinex we're passionate about design, crafting timber to create the world's most beautiful spaces while protecting and regenerating the forests that support us. Whatever you're envisioning, Modinex makes it possible to bring your concept to reality, through the use of natural timber, aluminium and concrete design solutions. Modinex brings inspiration and timber ingenuity to your project, through passion, design & relentless pursuit of innovation & sustainability.

Table of Contents

| | | | |
|---|--|----|--|
| 4 | BeachClad Channel Cladding - Sawn Face | 9 | Shiplap |
| 4 | Castelation® & Castelation® Screenshot | 9 | Shingles |
| 5 | Castelation® Stepped Expression | 9 | Rusticated Chamfer |
| 6 | Castelation® Screenshot TwoTone | 10 | Channel |
| 6 | Double Round Clad | 10 | Diamond Clad |
| 6 | Rib Clad | 11 | Weatherboard |
| 6 | Pin Stripe | 11 | Fluted |
| 7 | Expresswood Vee-Joint | 11 | Flat Panel |
| 7 | Kulture | 11 | Castelation® Stack |
| 7 | Scandinavian | 12 | Altaché Clad |
| 8 | Vee-Joint | 13 | DAR - Dressed All Round (Square Dressed) |
| 8 | Reversible Vee-Joint / Shiplap | 13 | Trims |
| 8 | Vee-Joint – Double Sided | 15 | Sawn Cedar |



Shiplap in Western Red Cedar



Screenshot TwoTone in Hemlock

BeachClad Channel Cladding – Sawn Face

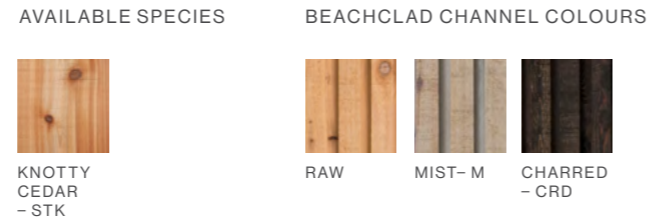
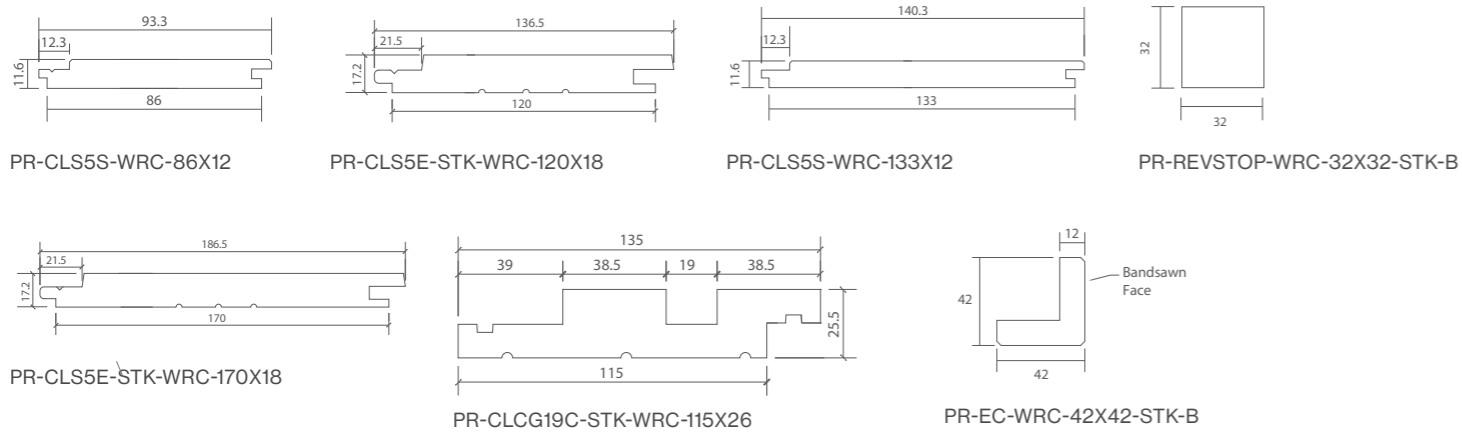

Castelation® & Castelation® Screenclad

CASTELATION® PROFILES

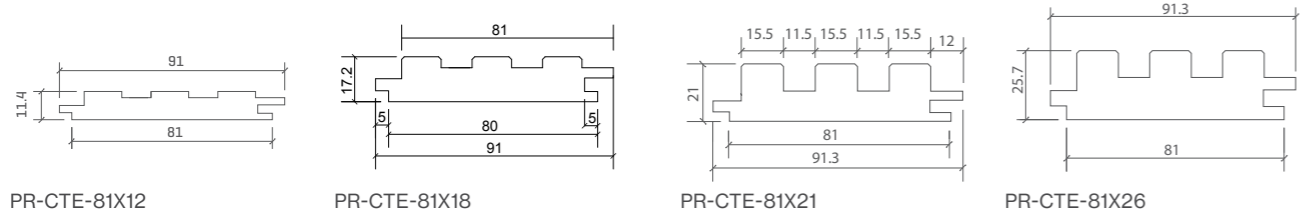

CASTELATION® SCREENCLAD PROFILES

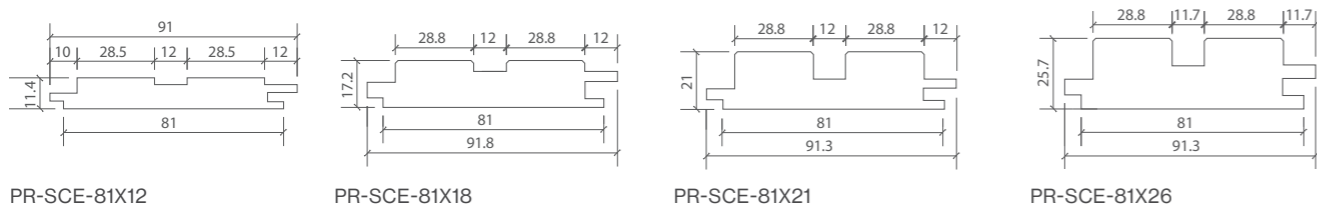

*Some profiles also available in Australian Hardwoods upon request; Blackbutt, Ironbark & Spotted Gum.

Castelation® Stepped Expression

CASTELATION® STEPPED EXPRESSION COMBINATIONS

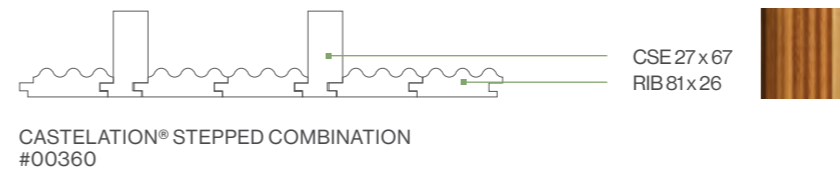
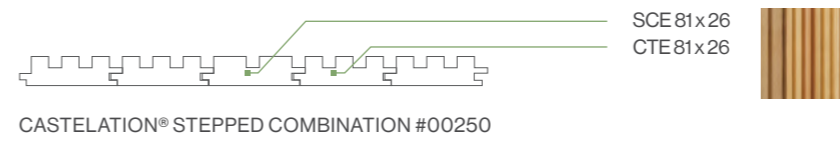
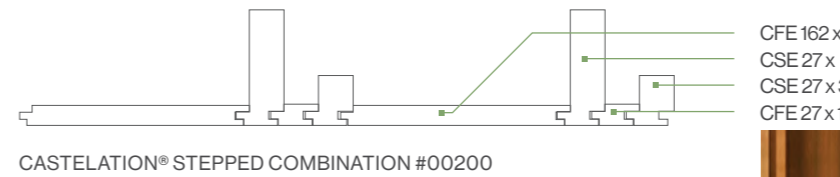
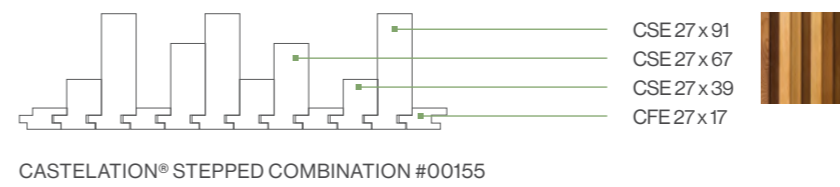
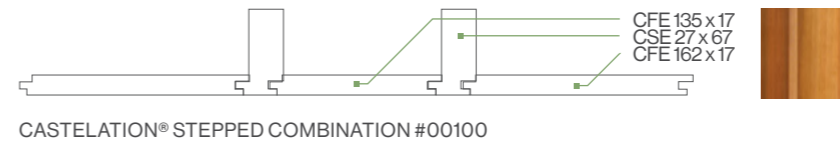
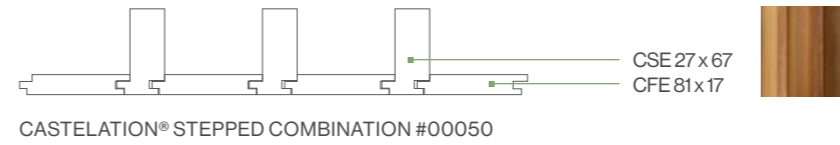
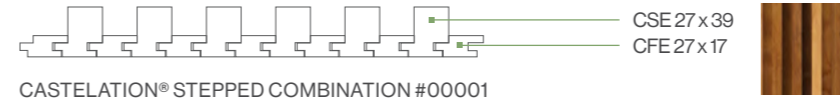

CASTELATION® STEPPED EXPRESSION PROFILES

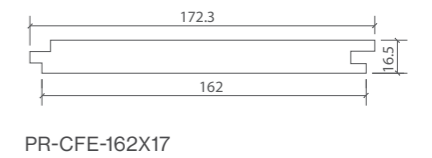
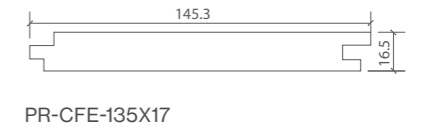
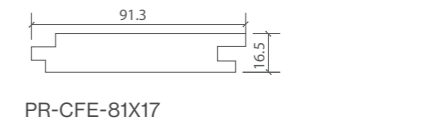

Note: Castelation® Flat Series can also be used by themselves, if a Flat, No groove or step is desired.

CASTELATION® STEPPED EXPRESSION - STEP SERIES PROFILES

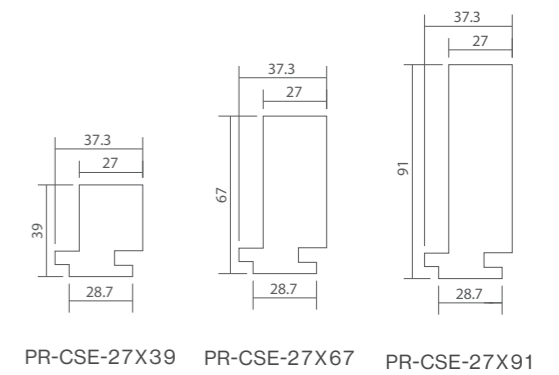

*Some profiles also available in Australian Hardwoods upon request; Blackbutt, Ironbark & Spotted Gum.

Castelation® Screenclad TwoTone

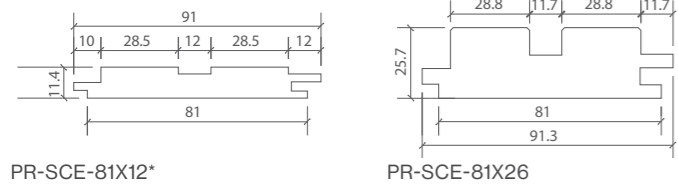

PR-SCE-81X12*

PR-SCE-81X26

*12mm thick Castelation® Screenclad TwoTone only stocked in Mocha MTT Cedar and Sago STT Cedar, other colours in 12mm Run To Order.

AVAILABLE SPECIES



WESTERN RED CEDAR - WRC
HEMLOCK - HEM

CASTELATION® SCREENCLAD & TWOTONE COLOURS



MOCHA - MTT CEDAR
SAGO - STT CEDAR
DOUBLE BLACK - DBTT HEMLOCK
DOUBLE WHITE - DWTT HEMLOCK

Rounds

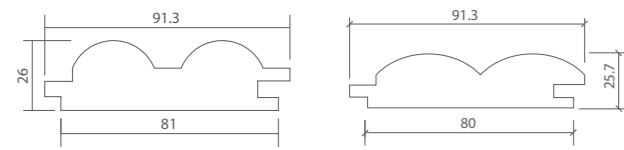

PR-DRC-81X26

CU-HDWL-81X26

AVAILABLE SPECIES



WESTERN RED CEDAR - WRC
ALASKAN CEDAR - YC
HEMLOCK - HEM

Convex

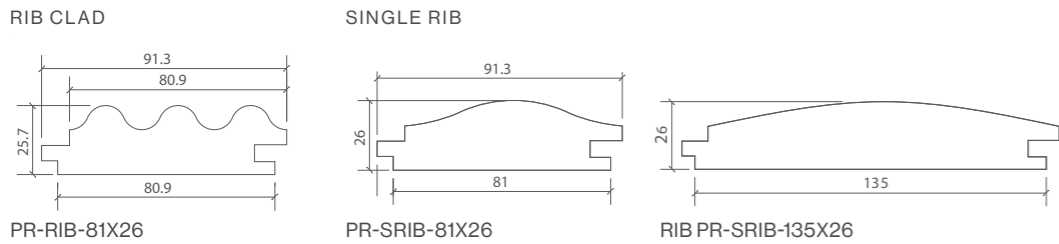

PR-RIB-81X26

PR-SRIB-81X26

RIB PR-SRIB-135X26

SINGLE RIB INVERTED

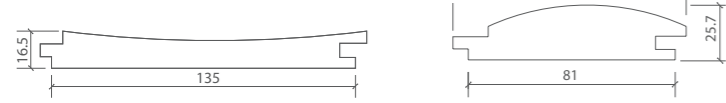

PR-SRIBIN-135X17

PR-SRIB-81X26

AVAILABLE SPECIES



WESTERN RED CEDAR - WRC
ALASKAN CEDAR - YC
HEMLOCK - HEM

Pin Stripe



PR-PS16-WRC-133X12

AVAILABLE SPECIES COLOURS



CEDAR - WRC
WHITE - BLK
WHITE - WTE

*Some profiles also available in Australian Hardwoods upon request; Blackbutt, Ironbark & Spotted Gum.

Expresswood Vee-Joint (Hemlock)

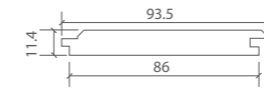

PR-VJSEW-86X12

AVAILABLE SPECIES



HEMLOCK - HEM

EXPRESSWOOD VEE-JOINT COLOURS (IN HEMLOCK)



RAW
BLACK WASH - BLW
CHARRED COPPER - CC
GREY WASH - GW
NATURAL SATIN - NS
RED WASH - RW
WHITE WASH - WW

Hex Clad

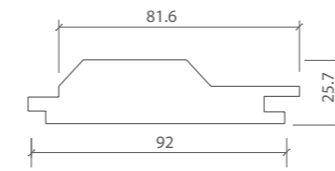

PR-HEXSG-81X26

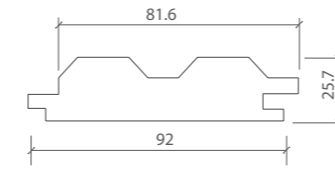

PR-HEXDB-81X26

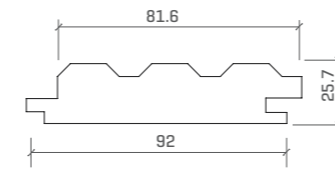

PR-HEXTP-81X26

AVAILABLE SPECIES



WESTERN RED CEDAR - WRC
ALASKAN CEDAR - YC
HEMLOCK - HEM

HEX CLAD TWOTONE COLOURS



BLACK
COGNAC
MANGROVE
EVENING HAZE

*Some profiles also available in Australian Hardwoods upon request; Blackbutt, Ironbark & Spotted Gum.

Vee-Joint

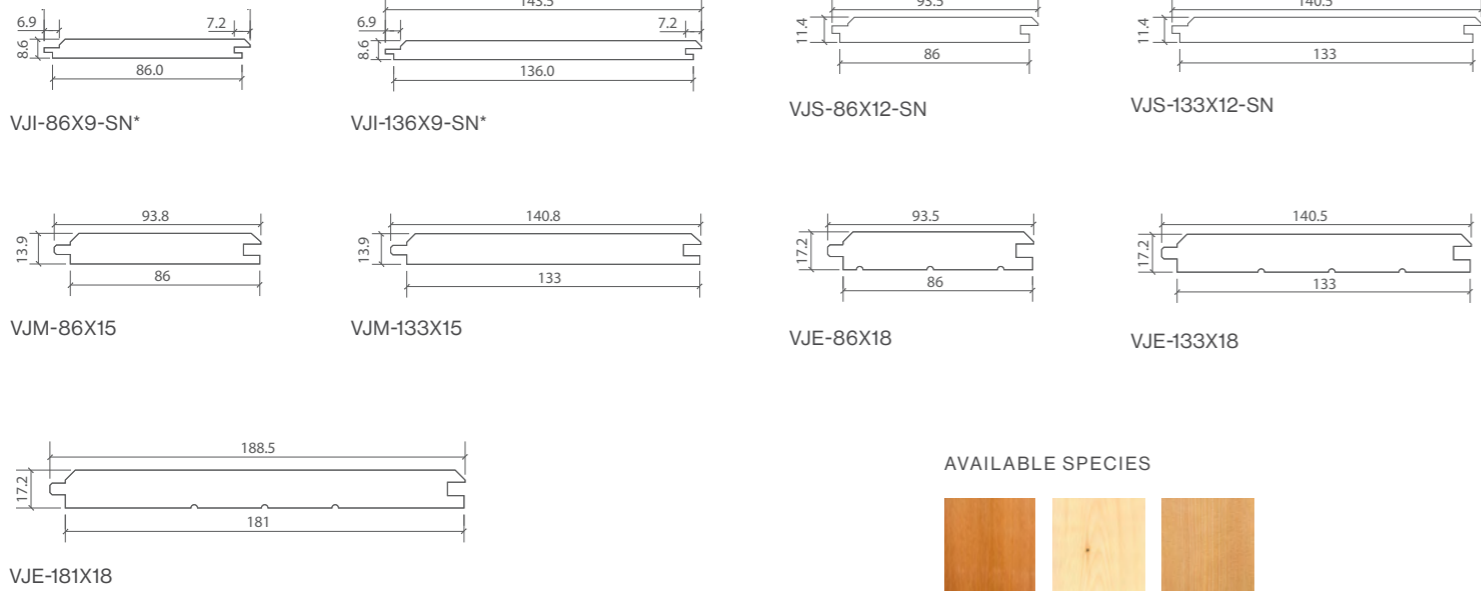

AVAILABLE SPECIES

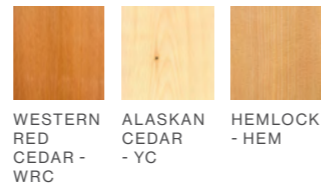

Shiplap

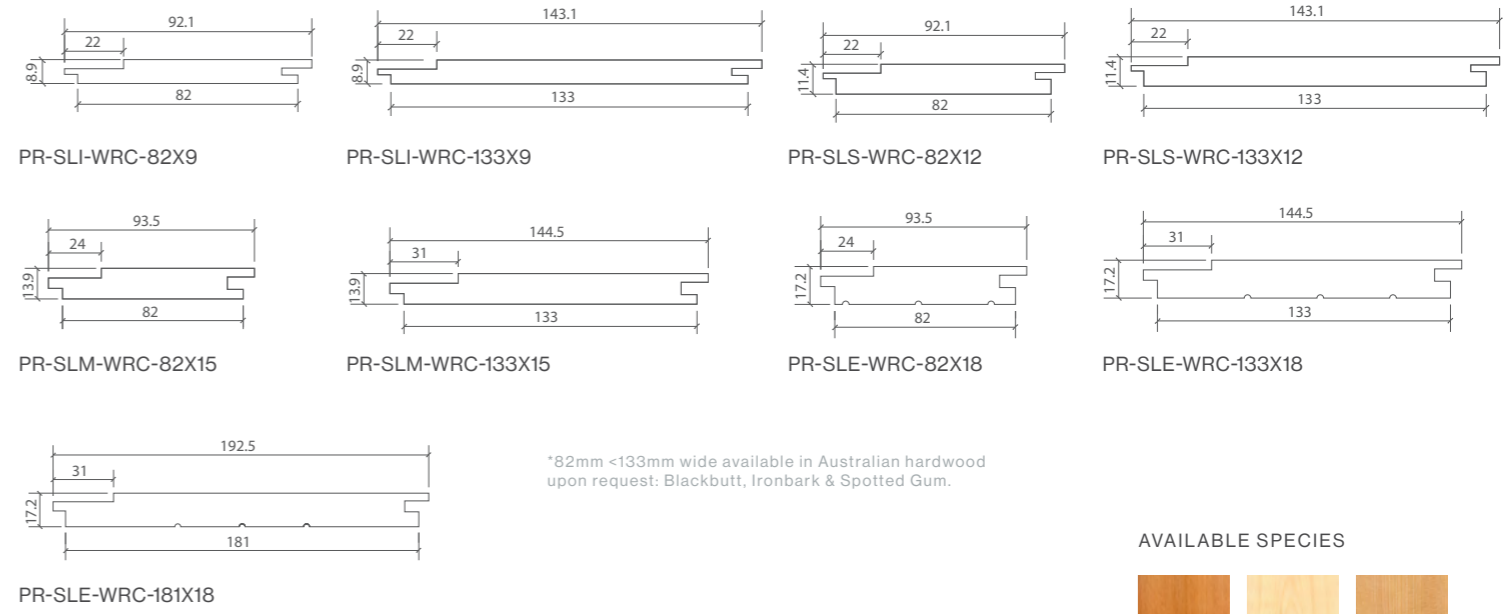

AVAILABLE SPECIES

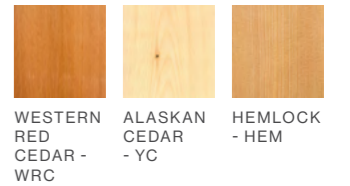

Vee-Joint - Double Sided

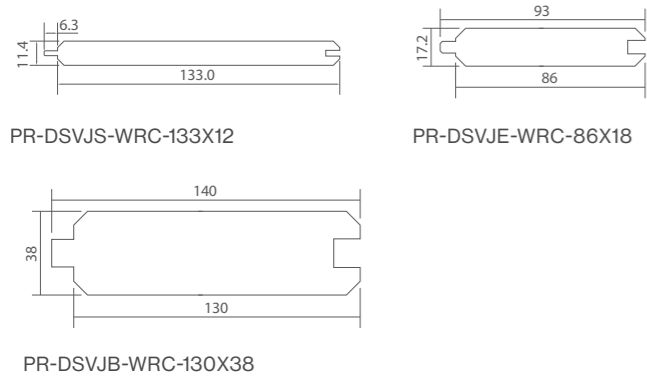

AVAILABLE SPECIES

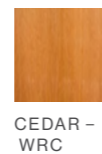

VEE-JOINT - DOUBLE SIDED (IN CEDAR)



VEE JOINT

Shingles

Grade: No.1 Blue Label Premium Clear Grade
Shingle Size: 450mm (Nominal Length)
11mm thick
butt widths: Various
Cover: 2.3m² per bundle @ 150mm exposure when laid

AVAILABLE SPECIES

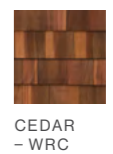

CEDAR - WRC

Reversible Vee-Joint / Shiplap

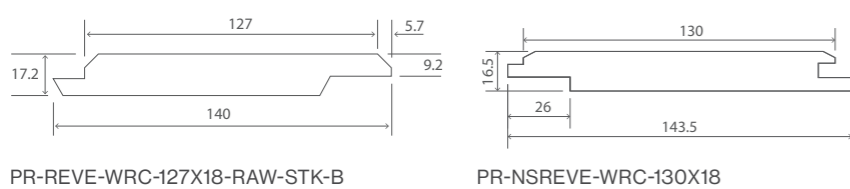

AVAILABLE SPECIES

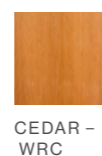

CEDAR - WRC

REVERSIBLE VEE-JOINT / SHIPLAP COLOURS



VEE JOINT SHIPLAP

Rusticated Chamfer

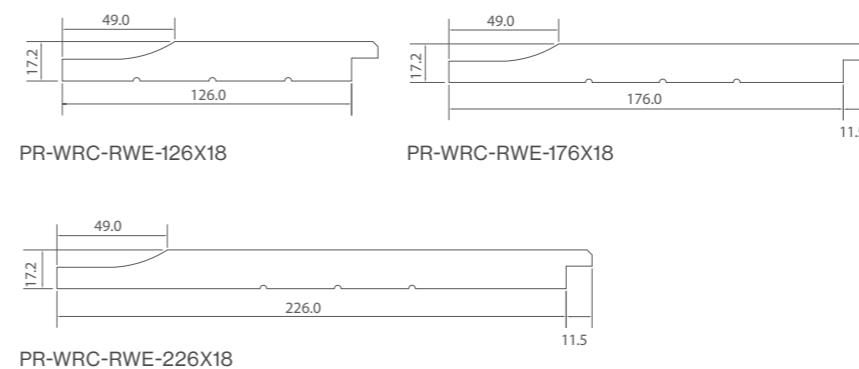

AVAILABLE SPECIES

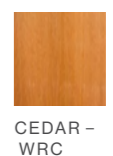

CEDAR - WRC

*Some profiles also available in Australian Hardwoods upon request; Blackbutt, Ironbark & Spotted Gum.

*Some profiles also available in Australian Hardwoods upon request; Blackbutt, Ironbark & Spotted Gum.

Channel

CHANNEL PROFILES

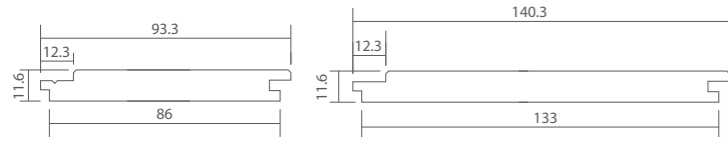

PR-CLS5S-WRC-86X12* PR-CLS5S-WRC-133X12*

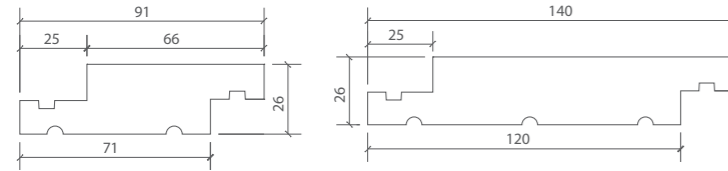

PR-CLS5C-WRC-71X26 PR-CLS5C-WRC-120X26

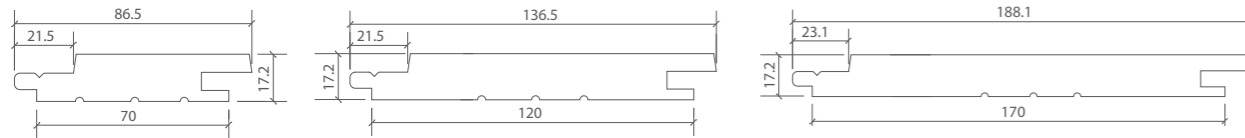

PR-CLS5E-WRC-70X18 PR-CLS5E-WRC-120X18 PR-CLS5E-WRC-170X18

CHANNEL WITH CENTRE GROOVE PROFILES

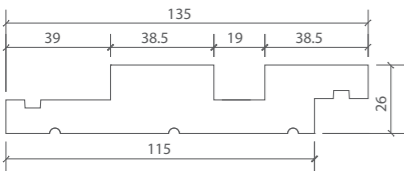

PR-CLCG19C-WRC-115X26

*12mm < 18mm thick available in Australian hardwood upon request: Blackbutt, Ironbark & Spotted Gum.
 * 12mm Available in Hemlock.

AVAILABLE SPECIES



Weatherboard

AVAILABLE SPECIES

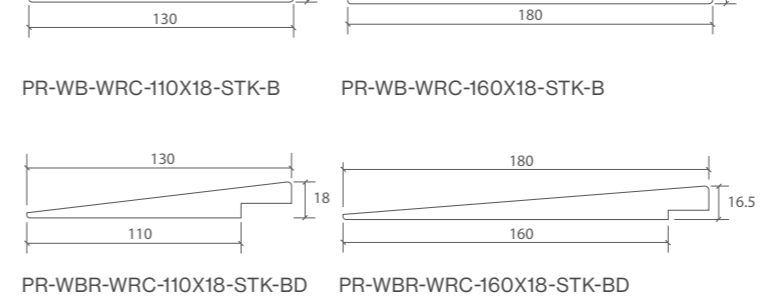

PR-WB-WRC-110X18-STK-B PR-WB-WRC-160X18-STK-B
 PR-WBR-WRC-110X18-STK-BD PR-WBR-WRC-160X18-STK-BD



KNOTTY CEDAR - STK

STK Profiles are Select Tight Knot Grade.

Flute & Concave

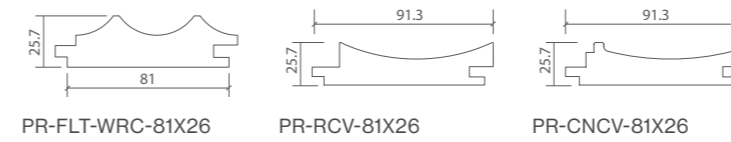

PR-FLT-WRC-81X26 PR-RCV-81X26 PR-CNCV-81X26

AVAILABLE SPECIES

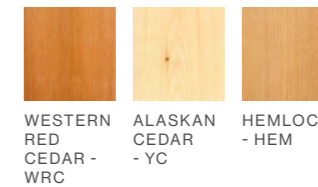

FLUTED COLOURS



*Available in Australian Hardwoods upon request: Blackbutt, Ironbark & Spotted Gum.

Flat Panel

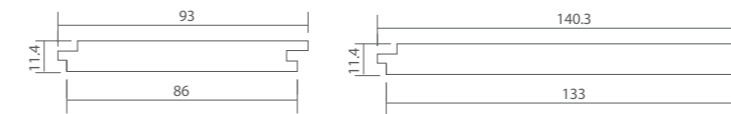

PR-FPS-WRC-86X12 PR-FPS-WRC-133X12

AVAILABLE SPECIES



FLAT PANEL [IN CEDAR]

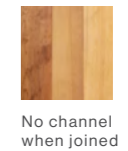

*Available in Australian Hardwoods upon request: Blackbutt, Ironbark & Spotted Gum.

Diamond Clad

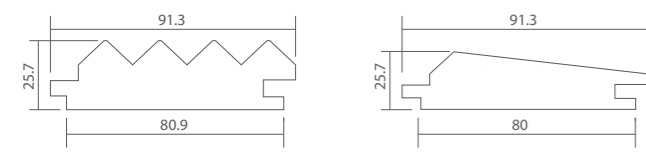

DIA-81X26 PR-CMF-81X26

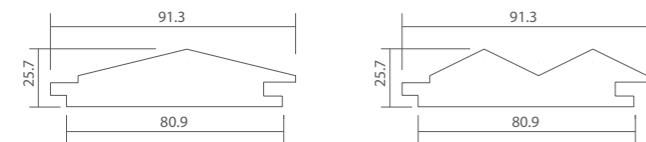

PR-SDIA-81X26 PR-DDIA-81X26

AVAILABLE SPECIES

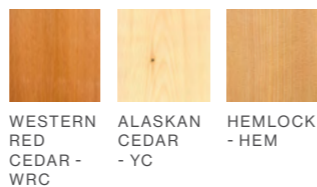

*Some profiles also available in Australian Hardwoods upon request; Blackbutt, Ironbark & Spotted Gum.

Castellation® Stack

CASTELATION® ROUGH STACK CASTELATION® SMOOTH STACK

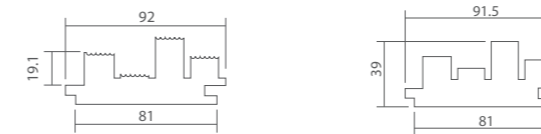

PR-CRS-WRC-81X39 PR-CSS-WRC-81X39

AVAILABLE SPECIES

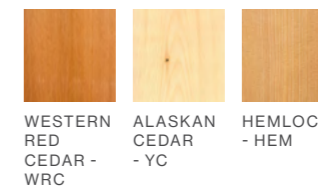

ROUGH STACK [IN CEDAR] SMOOTH STACK [IN CEDAR]



*Some profiles also available in Australian Hardwoods upon request; Blackbutt, Ironbark & Spotted Gum.

DAR – Dressed All Round

| | |
|--|----------------------|
|  | PR-DAR-WRC-12X12 |
| | PR-DAR-WRC-19X12 |
| | PR-DAR-WRC-31X12 |
| | PR-DAR-WRC-40X12 |
| | PR-DAR-WRC-67X12 |
| | PR-DAR-WRC-91X12 |
| | PR-DAR-WRC-116X12 |
| | PR-DAR-WRC-140X12 |
| | PR-DAR-WRC-190X12 |
| | PR-DAR-WRC-220X12 |
| | PR-DAR-WRC-18X18 |
| | PR-DAR-WRC-18X18-CS |
| | PR-DAR-WRC-18X18-P |
| | PR-DAR-WRC-18X18-SBW |
| | PR-DAR-WRC-18X18-W |
| | PR-DAR-WRC-31X18 |
| | PR-DAR-WRC-40X18 |
| | PR-DAR-WRC-67X18 |
| | PR-DAR-WRC-91X18 |
| | PR-DAR-WRC-116X18 |
| | PR-DAR-WRC-140X18 |
| | PR-DAR-WRC-190X18 |
| | PR-DAR-WRC-240X18 |
| | PR-DAR-WRC-290X18 |
| | PR-DAR-WRC-30X30 |
| | PR-DAR-WRC-40X30 |
| | PR-DAR-WRC-67X30 |
| | PR-DAR-WRC-91X30 |

DAR – Dressed All Round

| | |
|--|-------------------|
|  | PR-DAR-WRC-116X30 |
| | PR-DAR-WRC-140X30 |
| | PR-DAR-WRC-190X30 |
| | PR-DAR-WRC-240X30 |
| | PR-DAR-WRC-290X30 |
| | PR-DAR-WRC-40X40 |
| | PR-DAR-WRC-67X40 |
| | PR-DAR-WRC-91X40 |
| | PR-DAR-WRC-116X40 |
| | PR-DAR-WRC-140X40 |
| | PR-DAR-WRC-190X40 |
| | PR-DAR-WRC-240X40 |
| | PR-DAR-WRC-290X40 |
| | PR-DAR-HEM-18X18 |
| | PR-DAR-HEM-31X18 |
| | PR-DAR-HEM-40X18 |
| | PR-DAR-HEM-67X18 |
| | PR-DAR-HEM-91X18 |
| | PR-DAR-HEM-140X18 |
| | PR-DAR-HEM-190X18 |
| | PR-DAR-HEM-30X30 |
| | PR-DAR-HEM-40X30 |
| | PR-DAR-HEM-40X40 |
| | PR-DAR-HEM-67X40 |
| | PR-DAR-HEM-91X40 |
| | PR-DAR-HEM-140X40 |
| | PR-DAR-HEM-190X40 |

Pencil Round Screening

| | |
|---|-------------------|
|  | PR-PR-WRC-40X18 |
| | PR-PR-WRC-67X18 |
| | PR-PR-WRC-91X18 |
| | PR-SRSM-WRC-67X40 |

Halfa Splayed

| | |
|---|-------------------|
|  | PR-HSPL-WRC-67X18 |
| | PR-HSPL-WRC-91X18 |

External Corner

| | |
|---|-----------------|
|  | PR-EC-WRC-18X18 |
| | PR-EC-WRC-30X30 |
| | PR-EC-WRC-40X40 |

D Mould

| | |
|---|----------------|
|  | PR-DM-WRC-19X8 |
|---|----------------|

Glasgow Joinery Bead

| | |
|---|----------------------|
|  | PR-GLASGOW-WRC-10X10 |
|---|----------------------|

Glazing Bead

| | |
|---|-----------------|
|  | PR-GB-WRC-18X12 |
| | PR-GB-WRC-22X12 |
| | PR-GB-WRC-30X12 |
| | PR-GB-WRC-40X12 |

Ovolo

| | |
|---|-----------------|
|  | PR-OV-WRC-12X12 |
| | PR-OV-WRC-18X18 |
| | PR-OV-WRC-22X22 |
| | PR-OV-WRC-29X29 |
| | PR-OV-WRC-40X40 |

Parting Bead

| | |
|---|-----------------|
|  | PR-PB-WRC-19X10 |
| | PR-PB-WRC-22X10 |
| | PR-PB-WRC-30X10 |

Pencil Round Cover Strip

| | |
|---|------------------|
|  | PR-PRCS-WRC-29X8 |
| | PR-PRCS-WRC-40X8 |

Quad

Lamb's Tongue & NSW Colonial

| | |
|---|---------------------|
|  | PR-NSLAMB-WRC-67X18 |
| | PR-NSLAMB-WRC-91X18 |

Post Mouldings

| | |
|---|-------------------|
|  | PR-POST-WRC-83X40 |
| | PR-WC-WRC-67X40 |

External Cladding Trim

| | |
|---|------------------|
|  | PR-ECT-WRC-40X40 |
| | PR-ECT-WRC-48X48 |

Quarter Round

| | |
|---|-----------------|
|  | PR-QD-WRC-9X9 |
| | PR-QD-WRC-12X12 |
| | PR-QD-WRC-18X18 |
| | PR-QD-WRC-22X22 |
| | PR-QD-WRC-29X29 |
| | PR-QD-WRC-40X40 |

Scotia

| | |
|---|-----------------|
|  | PR-SC-WRC-9X9 |
| | PR-SC-WRC-12X12 |
| | PR-SC-WRC-18X18 |
| | PR-SC-WRC-22X22 |
| | PR-SC-WRC-29X29 |
| | PR-SC-WRC-40X40 |

Internal Corner Fillet

| | |
|---|-----------------|
|  | PR-IC-WRC-12X12 |
|---|-----------------|

Aster Joinery Bead

| | |
|---|-------------------|
|  | PR-ASTER-WRC-12X8 |
|---|-------------------|

Snail Mould

| | |
|---|-----------------|
|  | PR-SN-WRC-30X12 |
| | PR-SN-WRC-40X12 |

Stop Bead

| | |
|---|-----------------|
|  | PR-SB-WRC-19X3 |
| | PR-SB-WRC-22X13 |
| | PR-SB-WRC-30X13 |
| | PR-SB-WRC-40X13 |
| | PR-SB-WRC-22X18 |
| | PR-SB-WRC-30X18 |

*Some profiles also available in Australian Hardwoods upon request; Blackbutt, Ironbark & Spotted Gum.

*Some profiles also available in Australian Hardwoods upon request; Blackbutt, Ironbark & Spotted Gum.

| Storm Mould |  PR-STM-WRC-30X17 PR-STM-WRC-40X17 |
|-------------|---|
|-------------|---|

| Spa & Hot Tub Components | PR-HTS-WRC-75X38 PR-HTS-WRC-125X38 |
|--------------------------|---------------------------------------|
|--------------------------|---------------------------------------|

| Awning Sill |  PR-AS-WRC-140X40 |
|-------------|---|
|-------------|---|

| Bottom Meeting Rail |  PR-BMR-WRC-42X33 |
|---------------------|---|
|---------------------|---|

| Glazing Bar |  PR-GBAR-WRC-33X18 |
|-------------|---|
|-------------|---|

| Sash Bottom Rail |  PR-SBR-WRC-91X33 |
|------------------|---|
|------------------|---|

| Sash Joinery Bead |  PR-SASH-WRC-8X8 |
|-------------------|---|
|-------------------|---|

| Sash Style |  PR-SST-WRC-55X33 |
|------------|---|
|------------|---|

| Single Rebated Jamb |  PR-SRJ-WRC-140X40 |
|---------------------|--|
|---------------------|--|



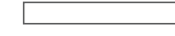

| Top Meeting Rail |  PR-TMR-WRC-42X33 |
|------------------|---|
|------------------|---|

| Western Red Cedar Rough Sawn 21mm |  RM-RS-WRC-50X21 RM-RS-WRC-75X21 RM-RS-WRC-100X21 RM-RS-WRC-150X21 RM-RS-WRC-200X21 |
|-----------------------------------|---|
|-----------------------------------|---|

| Western Red Cedar Rough Sawn 45mm |  RM-RS-WRC-45X45 RM-RS-WRC-75X45 RM-RS-WRC-100X45 RM-RS-WRC-125X45 RM-RS-WRC-150X45 RM-RS-WRC-200X45 |
|-----------------------------------|---|
|-----------------------------------|---|

| Western Red Cedar Rough Sawn 50mm |  RM-RS-WRC-50X50 RM-RS-WRC-75X50 RM-RS-WRC-100X50 RM-RS-WRC-125X50 RM-RS-WRC-150X50 RM-RS-WRC-175X50 RM-RS-WRC-200X50 RM-RS-WRC-250X50 RM-RS-WRC-300X50 |
|-----------------------------------|--|
|-----------------------------------|--|









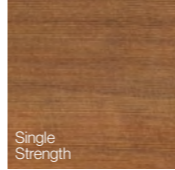

Timber Species

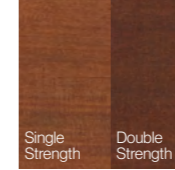
| | | | | |
|--|---|--|---|---|
|  Western Red Cedar Plantation 100% PEFC Certified Greentag Certified |  Western Red Cedar - Tight Knot Plantation 100% PEFC Certified |  Alaskan Cedar Plantation 100% PEFC Certified |  Hemlock Plantation 100% PEFC Certified Suitable for indoor and out-of weather use only |  Hemlock - Thermally Modified Plantation 100% PEFC Certified |
|--|---|--|---|---|

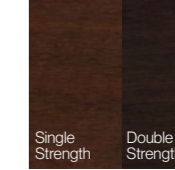

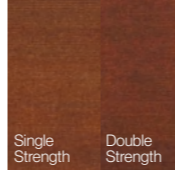
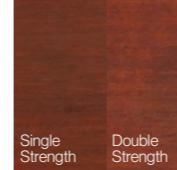
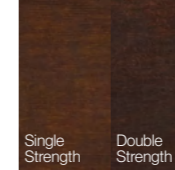
Finishes

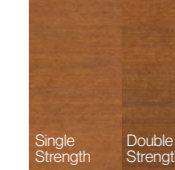
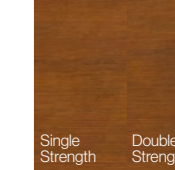
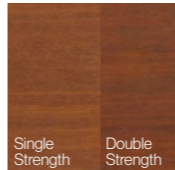
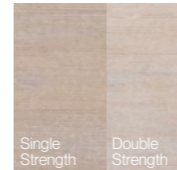
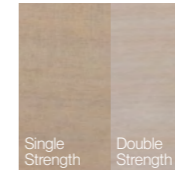
All timber profiles are available in a range of timber finishes such as clear satin, clear matt or an oiled finish. Clear satin and matt finishes are only suitable for internal use. For external use, please refer to the below oiled finishes. Please note these images are what our oiled finishes looks like on Western Red Cedar. The tone will vary if used on another species and it is recommended that you request a sample prior to ordering.

Oiled Finishes

| | | | | | |
|---|--|--|---|---|---|
|  Single Strength Double Strength Clear |  Single Strength Double Strength Sela Brown |  Single Strength Double Strength New Bronzestone |  Single Strength Double Strength Burnt Ash |  Single Strength Double Strength Walnut |  Single Strength Double Strength Cedartone |
|  Single Strength Double Strength Autumntone |  Single Strength Double Strength Burnt Red |  Single Strength Double Strength Merbau |  Single Strength Double Strength Light Oak |  Single Strength Double Strength Goldtone |  Single Strength Double Strength Honeycomb |
|  Single Strength Double Strength Rustic Gold |  Single Strength Double Strength White Wash |  Single Strength Double Strength Grey Mist |  Single Strength Double Strength Smokey Grey |  Single Strength Double Strength Black Ash | |

Raw, Clear Satin or Matt Finishes

| | | |
|---|--|---|
|  WESTERN RED CEDAR - WRC |  ALASKAN CEDAR - YC |  HEMLOCK - HEM |
|---|--|---|

*Hemlock is only suitable of out of weather applications only

*Some profiles also available in Australian Hardwoods upon request; Blackbutt, Ironbark & Spotted Gum.

*Some profiles also available in Australian Hardwoods upon request; Blackbutt, Ironbark & Spotted Gum.

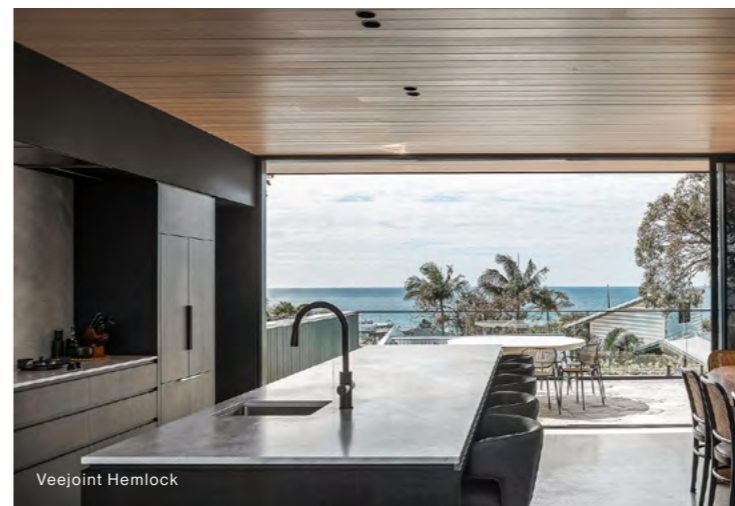



CHANNEL CLADDING IN HEMLOCK 86X12MM



Group 3
Fire Rating



Unrivalled
sustainability



Internal Structure
& Performance

Choose Cedar Sales and specify with confidence

Cedar Sales is committed to quality and performance you can count on. Our genuine architectural timber innovations are proven to perform where it matters most. As part of our commitment to provide market-leading quality and integrity, Cedar Sales welcomes third-party testing and certification for internal panelling compliance.



CEDAR SALES
BY Modinex

Head Office

Springfield Tower
Level 7/145 Sinnathamby Blvd
Springfield Central QLD 4300

P—1800 156 455
E—hello@modinex.com.au
modinex.com.au

Sydney
Melbourne
Adelaide
Canberra
Perth
Newcastle



PEFC Certified
This product is from
sustainably managed forest
and controlled sources.
Recognised in Australia by
Responsible Wood.
www.pefc.org.au

May 2024 Publication

Photographs, images and drawings used herein are for illustration purposes only. Colours, grades and finishes on actual products may vary. All timber products will vary from samples. Being a natural product, expect sheen, tonal and colour variation and natural features including knots, grains and grain impressions. We recommend viewing all products prior to installation. Cedar Sales is unable to offer any specific performance warranties for its products because of the wide variation in applications possible. These variables include but are not limited to; situation, design and structure, aspect and differing exposure to the weather. For more details, visit cedarsales.com.au/terms-and-condition-of-trade.